



**POLARIS**

# SPORTSMAN<sup>®</sup>



**POLARIS**

# ACE<sup>®</sup>

**2017 ACCESSORIES & GARAGE**

INTL VERSION

# GET ON SOME OFF-ROAD.

The Polaris® Sportsman® is engineered to be the hardest working, smoothest riding ATV available.

**POLARIS**  
**SPORTSMAN**®

## SINGLE SEAT FREEDOM. ABSOLUTE ADVENTURE.

As a new kind of off-road adventure, Polaris ACE® combines the performance of Polaris® with the confidence of a centered driving experience.

**POLARIS**  
**ACE**®

### FIND YOUR MODEL

RECREATION/UTILITY



**SPORTSMAN® 450 H.O. (EPS)**  
33HP



**NEW**  
**SPORTSMAN® 450 H.O. UTILITY EDITION**  
33HP



**SPORTSMAN® 570 (EPS)**  
44HP



**NEW**  
**SPORTSMAN® 570 (EPS) UTILITY EDITION**  
44HP



**SPORTSMAN® 570 SP**  
44HP

SPORT/UTILITY



**NEW**  
**SPORTSMAN® 850**  
78HP



**NEW**  
**SPORTSMAN® 850 SP**  
78HP



**NEW**  
**SPORTSMAN XP® 1000**  
91HP

6X6



**NEW**  
**SPORTSMAN® BIG BOSS 6X6 570 EPS**  
44HP

2-UP & UTILITY



**SPORTSMAN® X2 570 EPS**  
44HP



**SPORTSMAN® TOURING 570 (EPS)**  
44HP



**SPORTSMAN® TOURING 570 SP**  
44HP



**SPORTSMAN® TOURING 850 SP**  
78HP



**SPORTSMAN® TOURING XP 1000**  
88HP

SPORT



**SCRAMBLER® 850**  
78HP



**SCRAMBLER® XP 1000**  
89HP

MUD



**SPORTSMAN® 850 HIGH LIFTER EDITION**  
78HP



**SPORTSMAN XP® 1000 HIGH LIFTER EDITION**  
85HP

POLARIS ACE



**ACE® 500**  
32HP



**ACE® 570**  
45HP



**ACE® 570 SP**  
45HP



**NEW**  
**ACE® 900 XC**  
78HP

### POLARIS SPORTSMAN ACCESSORIES

ENGINEERED	02
RECREATION	04
UTILITY	06
HUNT	08
BUMPERS / GUARDS	10
WINDSHIELDS	12
RACKS	14
STORAGE	16
BIG BOSS	21
SCRAMBLER®	22

### POLARIS ACE ACCESSORIES

ENGINEERED	24
PERFORMANCE REC	26
RECREATION	28
ROOFS / WINDSHIELDS	30
REAR PANELS / DOORS	31
STORAGE	32
BUMPERS / GUARDS	34

### COMMON ACCESSORIES

AUDIO	36
WINCHES	38
PLOWS	40
LIGHTING	42
WHEELS / TIRES	44
TRACKS	48
TECHNOLOGY	49
OIL / LUBRICANTS	50
PARTS / TRAILER	52
GARAGE	54
APPAREL	56

**POLARIS**

ENGINEERED PARTS  
ACCESSORIES & APPAREL

# ENGINEERED FOR THE ULTIMATE OFF-ROAD EXPERIENCE

From the start, all of our accessories are specifically designed, rigorously tested, and meticulously fine-tuned to fit your Sportsman. We use industry-exclusive technologies and integration methods to guarantee an unparalleled level of customization. With the all-new Sportsman XP 1000, 850 & 850 SP every new accessory was developed alongside the machine, giving you a premium fit and style to match. Because the ultimate machines demand the ultimate accessories.

## LOCK & RIDE

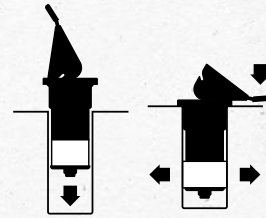

An industry exclusive, Polaris Lock & Ride® system has revolutionized off-road vehicle customization. Lock & Ride® products are specifically designed to be installed quickly and without hassle.

## EXPANSION WEDGE ANCHORS

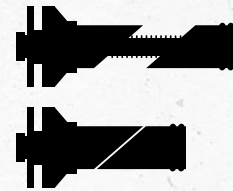

Tough expansion anchor wedges integrate right into the frame of your Sportsman® Ultimate Series, and allow for quick install of rock sliders and bumpers, without damaging the vehicle's frame.

## PRE-WIRED TECHNOLOGIES



Every Sportsman® comes winch-ready, equipped with factory-installed wiring built into the chassis.

# CHOOSE YOUR RIDE, MAKE IT YOURS.

WITH THESE **NEW** PRODUCTS FOR 2017

Innovation never rests and neither does our drive to help you get the most out of your Polaris® Sportsman®.

**NEW**

**TOP SELLER**

Look for the new and top seller icons throughout the book for the latest and greatest Polaris Engineered® Accessories.



## SEE THE ALL **NEW** LINE OF SPORTSMAN® ULTIMATE SERIES ACCESSORIES



## **NEW** RACKS & BUMPERS FOR WORK P.10 SPORTSMAN® 570/450 H.O.



## **NEW** POLARIS NORTHSTAR® COOLER & ACCESSORIES P.20



## **NEW** PRO ARMOR® WHEELS & TIRES P.44

## GET THE ESSENTIALS FOR YOUR SPORTSMAN®

PROTECTION  
P. 10

WINDSHIELDS  
P. 12

STORAGE SOLUTIONS  
P. 16

WINCHES  
P. 38

PLOWS  
P. 40

WHEELS & TIRES  
P. 44

# THE ULTIMATE ATV



No matter where the trail takes you, you can rely on your all-new, completely redesigned Sportsman XP® 1000, 850 & 850 SP and its new line of Polaris Engineered Ultimate Series Accessories™ to help you own your day off-road. Add everything from brushguards and lighting to windshields and storage racks to ensure you're better equipped for the ultimate off-road ride.

## POLARIS® SPORTSMAN XP® 1000 STEALTH BLACK

- A. SPORTSMAN® ULTIMATE SERIES - WINDSHIELD FAIRING **NEW** | 2882020
- B. SPORTSMAN® ULTIMATE SERIES - RACK EXTENDER 4" (FRONT & REAR) | 2882022 & 2882023 **NEW**
- C. SPORTSMAN® ULTIMATE SERIES - FRONT BUMPER **NEW TOP SELLER** | 2882020
- D. LED LIGHT BAR HARNESS | 2882320
- POLARIS® 12" LED LIGHT BAR | 2879500
- E. POLARIS® PRO HD 3500 LB WINCH | 2880435
- F. SPORTSMAN® ULTIMATE SERIES - BODY ARMOR **NEW** | 2882090
- G. POLARIS NORTHSTAR® COOLER - 30 QT | 2881315
- H. POLARIS® RATCHET TIE-DOWN STRAPS - BLACK | 2859047-02
- I. PRO ARMOR® WHEEL & TIRE SET: THRASHER - LUSTER & ATTACK | 2881377
- J. SPORTSMAN® ULTIMATE SERIES - LOCK & RIDE® REAR CARGO BOX | 2882026
- K. SPORTSMAN® ULTIMATE SERIES - REAR CARGO HOLD BAG **NEW** | 2882303
- L. SPORTSMAN® ULTIMATE SERIES - REAR BUMPER **NEW TOP SELLER** | 2882021



# TAKE COMMAND

# OF YOUR WORK

## POLARIS® SPORTSMAN® 570 EPS UTILITY EDITION MAROON METALLIC

- A. SPORTSMAN® BOOM SPRAYER - 15 GAL **NEW** | 2882266
- B. SPORTSMAN® 570/450 H.O. STEEL RACK **NEW** (REAR) | 2882322
- C. PRO ARMOR® WHEEL & TIRE SET:  
AMPLIFY - ACCENT & HARVESTER 27R14 **NEW** | 2882388
- D. THROTTLE/THUMB WARMERS | 2877364
- E. QuickTap BATTERY POSTS **NEW** | 2882110
- F. SPORTSMAN® 570/450 TOUGH RACK **NEW** (FRONT) | 2882321
- G. SPORTSMAN® 570/450 FARM & RANCH FRONT BUMPER **NEW**  
(FRONT) | 2882301



Get the essentials and get to work. Gear up with an easy on, easy off 15 Gallon sprayer, and take on obstacles with a set of brushguards, new steel racks or a Polaris® HD Winch. No matter what your day brings, you can conquer any task.

# BE THE APEX PREDATOR

The biggest trophies are the hardest to find, but when you gear up your Sportsman® with the right hunting equipment, you'll be ready to elevate your game. Arm yourself with the right accessories so you're in a better position for the pursuit.

SPORTSMAN® 850 SP  
POLARIS PURSUIT® CAMO

- A. SPORTSMAN® ULTIMATE SERIES - FRONT BUMPER **NEW TOP SELLER** | 2882020
- B. POLARIS® HD 3500 LB. WINCH **TOP SELLER** | 2880435
  - » SYNTHETIC ROPE | 2875791
  - » AUTO-STOP UPGRADE KIT | 2879149
- C. SPORTSMAN® ULTIMATE SERIES - RACK EXTENDER 4" **NEW**  
(FRONT & REAR) | 2882022 & 2882023
- D. THROTTLE/THUMB WARMERS | 2877364
- E. SPORTSMAN ULTIMATE SERIES - REAR CARGO HOLD BAG **NEW** | 2882303
- F. KOLPIN STRONGHOLD® GUN BOOT XL TRANSPORT **NEW** | 2882430
- G. KOLPIN STRONGHOLD® AUTO-LATCH MOUNT **NEW** | 2882272
- H. SPORTSMAN® ULTIMATE SERIES - BODY ARMOR **NEW** | 2882090
- I. SPORTSMAN® ULTIMATE SERIES - REAR BUMPER **NEW** | 2882021

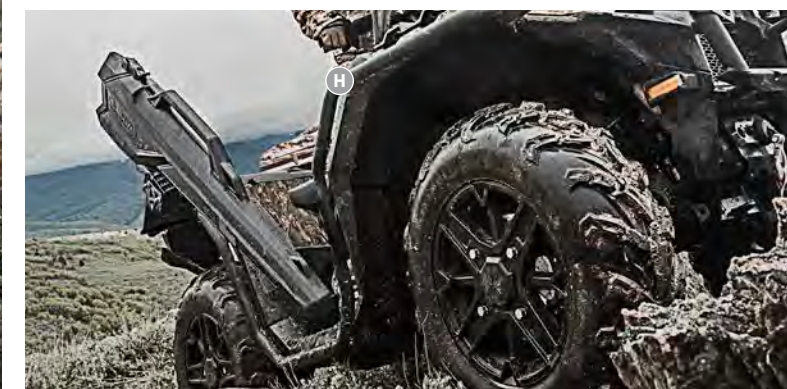

## BUMPERS & GUARDS

# ALL-TERRAIN PROTECTION



### SPORTSMAN XP® 1000 / 850 SP / 850

#### SPORTSMAN® ULTIMATE SERIES - FRONT BUMPER **NEW** TOP SELLER

- Quick installation with the wedge style expansion anchor mounts to the integrated mounting tubes on the vehicle
- Attach the all new Body Armor to the front bumper to provide the ultimate protection package for the front fenders
- Light bar mounting is quick and easy with the integrated mounting holes
- » 2882020
- XP 1000 MY 17, 850 SP MY 17, 850 MY 17

#### SPORTSMAN® ULTIMATE SERIES - BODY ARMOR **NEW**

- Securely mounts to new Sportsman XP® Front Bumper (2882020)
- » 2882090
- XP 1000 MY 17, 850 SP MY 17, 850 MY 17



#### SPORTSMAN® ULTIMATE SERIES - REAR BUMPER **NEW** TOP SELLER

- » 2882021
- XP 1000 MY 17, 850 SP MY 17, 850 MY 17

#### SPORTSMAN® ULTIMATE SERIES - FENDER FLARE KIT **NEW** FALL 2016

- » 2882455
- XP 1000 MY 17, 850 SP MY 17, 850 MY 17 (Not shown)

### 570 / 450 H.O.



#### FARM & RANCH FRONT BUMPER **NEW**

- Includes front receiver for additional functionality
- » 2882301
- 450 H.O. MY 16-17, ETX MY 15, 570 MY 14-17, 570 SP MY 15-17, 570 X2 MY 15-17, 570 X2 SP MY 16, TOURING 570 MY 14-17



#### SPORTSMAN® 570 / 450 H.O. BRUSHGUARD **TOP SELLER**

- Durable black powder-coating for long-lasting, scratch-resistant finish
- Integrated mounting location for easy installation and accessory lighting



#### FRONT BRUSHGUARD

- » 2879714
- 450 H.O. MY 16-17, ETX MY 15, 570 MY 14-17, 570 SP MY 15-17, 570 X2 MY 15-17, 570 X2 SP MY 16, TOURING 570 MY 14-17



#### REAR BRUSHGUARD

- » 2879715
- 450 H.O. MY 16-17, ETX MY 15, 570 MY 14-17, 570 SP MY 15-17, TOURING 570 MY 14-17

### 570 / 450 H.O. A-ARM GUARDS

#### FRONT A-ARM GUARDS

- » 2879889
- 450 H.O. MY 16-17, ETX MY 15, 570 MY 14-17, 570 SP MY 15-17, 570 X2 MY 15-17, 570 X2 SP MY 16, TOURING 570 MY 14-17

- Lightweight, durable guards provide reliable A-Arm protection
- HMW polyethylene construction delivers strength and low coefficient of friction so guards slide freely over rocks
- Guards absorb impacts and retain their shape rather than bending as metal guards can
- Engineered with integrated drain channels to evacuate water and mud

#### 570 / 450 H.O. REAR A-ARM GUARDS

#### REAR A-ARM GUARDS

- » 2880679
- 450 H.O. MY 16-17, ETX MY 15, 570 MY 14-17, 570 SP MY 15-17, 570 X2 MY 15-17, 570 X2 SP MY 16, TOURING 570 MY 14-17

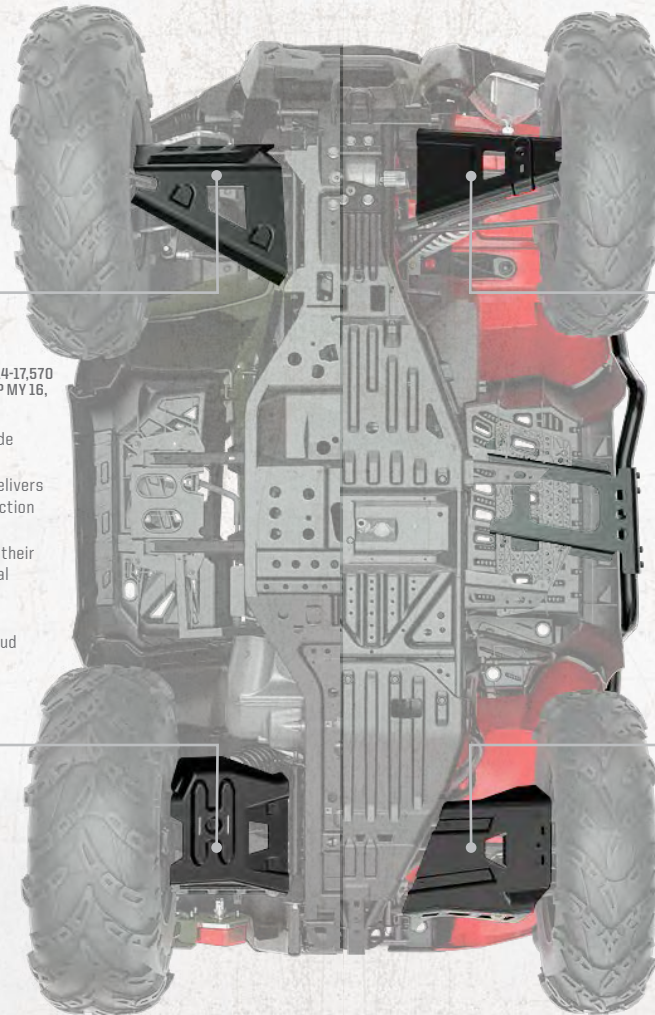

### XP TOURING

### SPORTSMAN XP® A-ARM GUARDS

#### FRONT A-ARM GUARDS

- » 2880644
- 850/850 SP MY 15-17, XP 1000 MY 15-16, TOURING XP 1000 MY 15-17

- Lightweight, durable guards provide reliable A-Arm protection
- HMW polyethylene construction delivers strength and low coefficient of friction so guards slide freely over rocks
- Guards absorb impacts and retain their shape rather than bending as metal guards can
- Engineered with integrated drain channels to evacuate water and mud

#### SPORTSMAN XP® REAR A-ARM GUARDS

#### REAR A-ARM GUARDS

- » 2880678
- 850/850 SP MY 15-17, XP 1000 MY 15-16, TOURING XP 1000 MY 15-17



#### SPORTSMAN XP® BRUSHGUARD **TOP SELLER**

- Durable black wrinkle powder-coating for long-lasting, scratch-resistant finish
- Integrated mounting location for easy installation and accessory lighting

#### FRONT

- » 2878709
- XP 1000 MY 15-16, 850 SP MY 15-16, 550/850 MY 10-16, TOURING XP 1000 MY 15-17

#### REAR

- » 2878710
- XP 1000, 850 SP MY 15-16, 550/850 MY 10-16



#### BODY GUARD

- Strong and durable 16-gauge, 1.5" (3.8 cm) tube construction
- » 2878341
- XP 1000 MY 15-16, 850 SP MY 15-16, 550/850 MY 10-16
- Does not fit High Lifter Editions, Does not fit with Sportsman® XP Fender Flare Kit 2878687



#### SPORTSMAN® TOURING REAR BRUSHGUARD

- Adds heavy-duty rear protection and a custom look
- » 2878324
- XP TOURING 1000 MY 15-17, TOURING 550/850 MY 10-17



#### FENDER FLARE KIT

- Provides an additional 3" of coverage for extra protection from mud and water
- Ideal for ATVs running accessory wheels with wider offsets
- » 2878687
- XP 550/850 MY 09-16, XP 1000 MY 15-16

### ALL SPORTSMAN®



#### HANDGUARDS

- Offer superior hand protection while enhancing vehicle style
- » 2876883 | White
- » 2876846 | Black
- » 2876845 | Red
- FITS ALL SPORTSMAN® MODEL WITH 2879380 INSTALLED



#### HANDGUARD MOUNT

- This handguard mount is required when installing Polaris® Handguards
- » 2879380
- FITS ALL POLARIS® ATV MODELS

## WINDSHIELDS

# GO HEAD FIRST

Stay focused on the ride ahead without having to worry about what's coming. Polaris Engineered™ windshields are the ideal solution for debris and branches without sacrificing your visibility.

SPORTSMAN XP® 1000 / 850 SP / 850

## CHOOSE YOUR LEVEL OF PROTECTION

**1** START WITH THE FAIRING

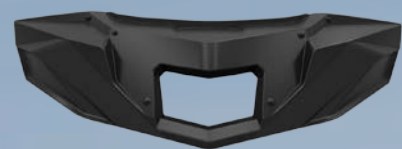

SPORTSMAN® ULTIMATE SERIES - WINDSHIELD FAIRING - FALL 2016 **NEW** TOP SELLER

- Customizable system based on your style and protection needs
- All new fairing is the base for the best wind protection system to date

» 2882512  
XP 1000 MY 17, 850 SP MY 17, 850 MY 17

**2** CHOOSE YOUR WINDSHIELD



SPORTSMAN® ULTIMATE SERIES WINDSHIELDS - FALL 2016

LOW VIEW **NEW**

» 2882150  
XP 1000 MY 17, 850 SP MY 17, 850 MY 17

MID VIEW **NEW**

» 2882151  
XP 1000 MY 17, 850 SP MY 17, 850 MY 17

TALL VIEW **NEW** TOP SELLER

» 2882152  
XP 1000 MY 17, 850 SP MY 17, 850 MY 17

**3** ACCESSORIZE

SPORTSMAN® ULTIMATE SERIES - WINDSHIELD FAIRING BAG - FALL 2016 **NEW**

» 2882454  
XP 1000 MY 17, 850 SP MY 17, 850 MY 17

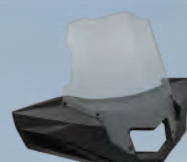

TALL VIEW HARD COAT - FALL 2016 **NEW**

» 2881161  
XP 1000 MY 17, 850 SP MY 17, 850 MY 17

### HARD-COAT

Give your impact resistant poly windshield extra defense. Hard-coat is 30x more scratch resistant, meaning you'll be able to handle whatever gets thrown at you.

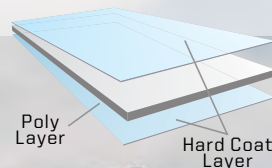

EASY TO CHANGE WINDSHIELDS WITH 6 DART INSTALL

## POLY WINDSHIELDS

Flexible, **IMPACT RESISTANT** material protects from impact and provides long term value

LOCK & RIDE

Tall 19.25" (48.9 cm)  
Clear

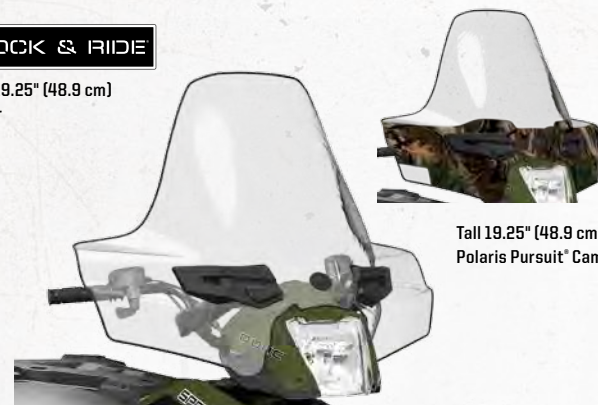

Tall 19.25" (48.9 cm)  
Polaris Pursuit® Camo

LOCK & RIDE

Mid 15.5" (39.4 cm)  
Black



Mid 15.5" (39.4 cm)  
Smoke

LOCK & RIDE

Low 9.5" (24.1 cm) Black



## SPORTSMAN XP® / 570 SP

LOCK & RIDE® SPORTSMAN® WINDSHIELDS

- » 2880539-587 | TALL 19.25" (48.9 cm) POLARIS PURSUIT® CAMO
- » 2880539-409 | TALL 19.25" (48.9 cm) CLEAR
- » 2880540-070 | MID 15.5" (39.4 cm) BLACK
- » 2880540-412 | MID 15.5" (39.4 cm) SMOKE
- » 2880541-070 | LOW 9.5" (24.1 cm) BLACK

570 SP 15-16, 850 SP 15-16, WV 850 14, 850/XP 1000 15-16, TOURING XP 1000 15-17, BIG BOSS 6X6 570 MY 17

## SPORTSMAN® 570 / 450 H.O.

LOCK & RIDE® SPORTSMAN® WINDSHIELDS

- » 2878389-587 | TALL 19.25" (48.9 cm) POLARIS PURSUIT® CAMO
- » 2878389 | TALL 19.25" (48.9 cm) CLEAR
- » 2878388-070 | MID 15.5" (39.4 cm) BLACK
- » 2878388 | MID 15.5" (39.4 cm) SMOKE
- » 2878387 | LOW 9.5" (24.1 cm) BLACK

570 MY 14-17, 570 SP MY 17, 570 X2 MY 15-17, 570 X2 SP MY 16, BIG BOSS 800 MY 14, TOURING 570 MY 14-17, ETX MY 15, 450 H.O. MY 16-17, 400/500/800 MY 05-15

LOCK & RIDE

EASY ON & OFF TOOL-FREE INSTALLATION



LOCK & RIDE



**A. LOCK & RIDE® ACCESSORY BAR MOUNT**

- Attaches to the windshield and has a 1" (2.4 cm) tube for a near-endless array of accessory mounting options

» 2878403

ETX MY 15, 450 H.O. MY 16-17, 570 MY 14-17, 570 SP MY 15-17, 570 X2 MY 15-17, 570 X2 SP MY 16, 850 SP MY 15-16, WV 850 MY 14, XP 1000 MY 15-16, BIG BOSS 800 MY 14, TOURING 570 MY 14-17, TOURING XP 1000 MY 15-17

**B. CUP HOLDER**

- Conveniently holds a cup, can or thermal mug on the inside of the windshield
- Requires Lock & Ride® Accessory Bar Mount (2878403 sold separately)

» 2878402

ETX MY 15, 450 H.O. MY 16-17, 570 MY 14-17, 570 SP MY 15-17, 570 X2 MY 15-17, 570 X2 SP MY 16, 850 SP MY 15-16, WV 850 MY 14, XP 1000 MY 15-16, BIG BOSS 800 MY 14, TOURING 570 MY 14-17, TOURING XP 1000 MY 15-17



RACKS

# STORAGE ALL AROUND

Rugged and versatile, rack extenders can be used to tie just about anything down, expanding your carrying capacity.



## SPORTSMAN® XP 1000 / 850 SP / 850

SPORTSMAN® ULTIMATE SERIES - RACK EXTENDER 7" **NEW**



FRONT

» 2882024  
XP 1000 MY 17, 850 SP MY 17, 850 MY 17

REAR

» 2882025  
XP 1000 MY 17, 850 SP MY 17, 850 MY 17  
Does not fit with Rack Extender 7" (2882025)

SPORTSMAN® ULTIMATE SERIES - RACK EXTENDER 4" **NEW**



FRONT

» 2882022  
XP 1000 MY 17, 850 SP MY 17, 850 MY 17

REAR

» 2882023  
XP 1000 MY 17, 850 SP MY 17, 850 MY 17  
Fits with Rear Cargo Box (2882026)

## 570 / 450 H.O.

SPORTSMAN® 570/450 H.O. STEEL RACK - FRONT & REAR **NEW**



FRONT

» 2882321  
570 MY 14-17, 570 SP MY 15-17, 570 X2 MY 15-17, 570 X2 SP MY 16, TOURING 570 MY14-17, ETX MY 15, 450 H.O. MY 16-17

REAR

» 2882322  
570 MY 14-17, 570 SP MY 15-17, ETX MY 15, 450 H.O. MY 16-17

SPORTSMAN® 570 / 450 H.O. RACK EXTENDERS **TOP SELLER**



FRONT

» 2879716  
570 MY 14-17, 570 SP MY 15-17, 570 X2 MY 15-17, 570 X2 SP MY 16, TOURING 570 MY 14-17, ETX MY 15, 450 H.O. MY 16-17

REAR

» 2879717  
570 MY 14-17, 570 SP MY 15-17, TOURING 570 MY 14-17, ETX MY 15, 450 H.O. MY 16-17

## XP TOURING

SPORTSMAN XP® RACK EXTENDERS



FRONT

» 2879890  
XP 550/850/1000 MY 09-16, TOURING 550/850/1000 MY 09-17, X2 550/850 MY10-16  
Does not fit vehicles with Front Cargo Box (2877951)

REAR

» 2879891  
SPORTSMAN® XP 550/850/1000 MY 09-16

SPORTSMAN XP® COMPOSITE RACK EXTENDERS



FRONT

» 2876598  
XP 550/850 MY 09-16, X2 550/850 MY 10-14

REAR

» 2876599  
XP 550/850/1000 MY 09-16

SPORTSMAN® ULTIMATE SERIES - MOVABLE TIE-DOWN POINTS **NEW**

- Screws into the front and rear platforms allowing for customized tie-down points
- Comes in pairs

» 2882270  
XP 1000 MY 17, 850 SP MY 17, 850 MY 17

CHECK OUT THE ALL NEW  
**LOCK & RIDE® YUKON ADVENTURE RACK P.21**

SPORTSMAN®  
**BIG BOSS 6X6**



## STORAGE

# ROOM FOR MORE

Quick to install and easy to access, our line of storage solutions turn your Sportsman® into a cargo carrying beast. No matter what you're bringing, you'll have the room to bring it.

### SPORTSMAN XP® 1000, 850 SP, 850



#### LOCK & RIDE

**SPORTSMAN® ULTIMATE SERIES - LOCK & RIDE® REAR CARGO BOX** **NEW** **TOP SELLER**  
 » 2882026  
 XP 1000 MY 17, 850 SP MY 17, 850 MY 17, FITS WITH RACK EXTENDER 4" 2882023, DOES NOT FIT WITH RACK EXTENDER 7" 2882025



#### SPORTSMAN® ULTIMATE SERIES - REAR CARGO HOLD BAG

» 2882303  
 XP 1000 MY 17, 850 SP MY 17, 850 MY 17



#### SPORTSMAN® ULTIMATE SERIES - READYPACK

» 2882271  
 XP 1000 MY 17, 850 SP MY 17, 850 MY 17

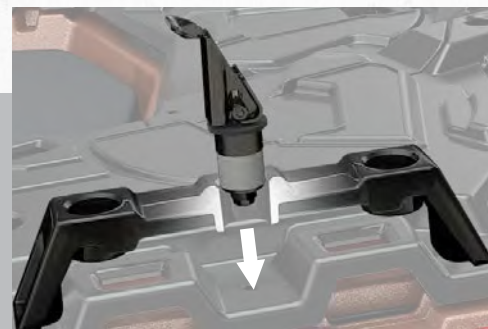

#### LOCK & RIDE

Exclusive and available on all Polaris® vehicles, Lock & Ride® accessories are designed to install quickly without tools or hassle. With the flip of a lever, Lock & Ride® plungers use downward pressure to expand for a secure fit.

### 570 / 450

#### LOCK & RIDE

**LOCK & RIDE® REAR CARGO BOX** **TOP SELLER**  
 • Large capacity, with locking latches and lid gaskets  
 » 2875176  
 570 MY 14-17, 570 SP MY 15-17, 850 SP MY 15-17, 850/XP 1000 HIGH LIFTER EDITION MY 16-17, XP 1000 MY 15-17, TOURING XP 1000 MY 15-17

**LOCK & RIDE® REAR CARGO BOX BACKREST**  
 • Attaches to Lock & Ride® Rear Cargo Box  
 » 2876367  
 FITS SPORTSMAN® LOCK & RIDE® REAR CARGO BOX (2875176)  
 INTENDED FOR OPERATOR USE ONLY

### XP TOURING



#### LOCK & RIDE

**LOCK & RIDE® FRONT CARGO BOX**  
 • Replaces stock rack, adds convenient storage location  
 • Durable injection-molded construction  
 • Styled to match the SPORTSMAN XP®  
 » 2877951  
 850/850 SP MY 15-16, XP 1000 MY 15-16, TOURING XP 1000 MY 15-17 (COMES STOCK)



#### FRONT CARGO BAG

» 2876602  
 850 SP MY 15-16, XP 1000 MY 15-16, TOURING XP 1000 MY 15-17, 550/850 MY 10-16



#### LOCK & RIDE® REAR STORAGE BOXES

» 2878000  
 XP TOURING 1000 MY 15-17  
 Slight interference with Sportsman® Touring 550/850 MY 11-14 passenger handles



#### SEMI-RIGID TOURING CARGO BAG

» 2877220  
 TOURING 570 MY 14-17



#### LOCK & RIDE

**LOCK & RIDE® BACKREST**  
 • Fits with Lock & Ride® Gun Boot Mount and Rack Extenders  
 • Fully adjustable for all-day comfort  
 » 2876616  
 850/850 SP MY 15-16, XP 1000 MY 15-16  
 Does not fit with Lock & Ride® Cargo Box (2876601) installed  
 » 2879887  
 570 MY 14-17, 570 SP MY 15-17, ETX MY 15, 450 H.O. MY 16-17  
 » 2878513  
 SPORTSMAN® 500/800 MY 11-14  
 Does not fit with Lock & Ride® Cargo Box (2876601) installed

**KOLPIN STRONGHOLD™ SYSTEM**

Polaris® is proud to partner with Kolpin® Powersports, an industry leader in off-road accessories and the premier name in gun boots and mounts. Our exclusive line of Kolpin® accessories are designed to fit and tested to work perfectly with your Polaris® Sportsman®.

**KOLPIN STRONGHOLD™ AUTO-LATCH MOUNT** **NEW**

» 2882272  
XP 1000 MY 17, 850 SP MY 17, 850 MY 17

**KOLPIN STRONGHOLD™ GUN BOOT XL TRANSPORT** **NEW**

» 2882430  
XP 1000 MY 17, 850 SP MY 17, 850 MY 17  
Requires Auto-Latch Mount (2882272)

**KOLPIN STRONGHOLD™ PRODUCTS SECURELY PROTECT THE ESSENTIALS WHEN ON THE TRAIL.**



**KOLPIN STRONGHOLD™ GUN BOOT L** **NEW**

» 2882426  
XP 1000 MY 17, 850 SP MY 17, 850 MY 17  
Requires Auto-Latch Mount (2882272)



**KOLPIN STRONGHOLD™ PISTOL BOOT** **NEW**

» 2882429  
XP 1000 MY 17, 850 SP MY 17, 850 MY 17  
Requires Auto-Latch Mount (2882272)



**KOLPIN STRONGHOLD™ ICE ROD BOOT** **NEW**

» 2882428  
XP 1000 MY 17, 850 SP MY 17, 850 MY 17  
Requires Auto-Latch Mount (2882272)



**RHINO GRIP™ XL BY KOLPIN™**

» 2881513  
ALL SPORTSMAN™



**RUBBER STRAPS BY KOLPIN™**

» 2881621  
ALL SPORTSMAN™



**RATCHETING RHINO GRIP™ XL BY KOLPIN™**

• Requires minimal rack space and attaches using Lock & Ride™ technology  
» 2881157  
ALL SPORTSMAN™

**SPORTSMAN™ BOOM SPRAYER - 15 GAL**

» 2882266  
ALL SPORTSMAN™, EXCEPT TOURING MODELS



**LOCK & RIDE**

**LOCK & RIDE™ GUN BOOT MOUNTS**

• High-impact case secures firearm over any terrain  
• Lock & Ride™ system mounts on right  
• Works with Lock & Ride™ XL Storage Box, Lock & Ride™ Rear Cargo Box, Rear Rack Extenders  
» 2877381  
XP 550/850/1000 MY 09-16  
» 2878001  
XP TOURING 550/850/1000 MY 10-16  
» 2875783  
X2 500/550/570/800/850  
» 2879888  
570 MY 14-17, 570 SP MY 15-17, 570 TOURING MY 14-17

**POLARIS™ GUN BOOTS™ BY KOLPIN™**

» 2872677 | BLACK  
» 2872677-419 | MOSSY OAK™ BREAK-UP™  
ALL POLARIS™ GUN BOOT™ MOUNTS, EXCEPT KOLPIN STRONGHOLD™



**LOCK & RIDE**

**LOCK & RIDE™ XL STORAGE BOX**

• Extra large storage capacity box with lid secured by four rubber clasps  
• Includes internal dividers and reversible lid for additional tie-down points  
• Requires mounting kit  
» 2881128-070

570 MY 14-17, 570 SP MY 15-17, 570 X2 MY 15-17, 570 X2 SP MY 16, 850/850 SP MY 15-17, XP 1000 MY 15-17, ETX MY 15, 450 HO MY 16-17



**LOCK & RIDE™ XL STORAGE BOX MOUNT**

• Tie-down straps are required for added cargo security  
» 2881931

570 MY 14-17, 570 SP MY 15-17, 570 X2 MY 15-17, 570 X2 SP MY 16, 850/850 SP MY 15-17, XP 1000 MY 15-17, ETX MY 15, 450 HO MY 16-17

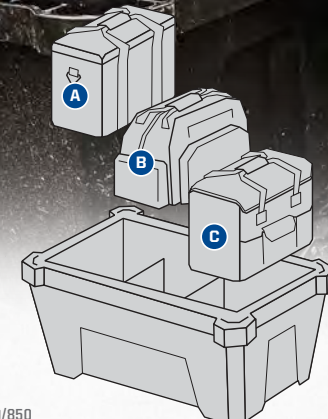

**FENDER BAG**

• Easy to access while seated  
• Pockets hold water bottles  
» 2876604  
FITS ALL SPORTSMAN™ MODELS. THE BAG DOES NOT WORK WITH THE FRONT STORAGE BOX (2877951).



**RIDE & REPAIR ESSENTIALS KIT**

• 12-volt DC portable air compressor  
• Tire repair kit with 6 plugs  
• Basic first-aid kit with bandages, scissors, safety pins and more  
• 12-volt jumper cables  
• Duct tape - 300mm x 1 roll  
• Zip ties - 150mm length  
• Electrical tape  
• Ratchet strap - 50mm  
• Microfiber cloth  
• Carry bag  
» 2881207  
ALL OFF-ROAD VEHICLES



**LOCK & RIDE™ PLUNGER**

» 2876420  
ALL SPORTSMAN™



**LOCK & RIDE™ D-RING PLUNGER**

» 2881544  
ALL SPORTSMAN™

**MISCELLANEOUS**



**HANDLEBAR-MOUNTED MIRROR**

• For added safety on or off the trail  
» 2877222  
ALL SPORTSMAN™ AND TRAIL BOSS™ MODELS, SCRAMBLER™ MY 10-14



**HANDLEBAR HAND WARMERS**

• Keep both hands warm while riding  
• Complete kit includes all wiring  
» 2877363  
ALL SPORTSMAN™ MODELS



**THROTTLE/THUMB WARMERS**

• Keeps throttle thumb warm  
• Complete kit includes all wiring  
» 2877364  
ALL SPORTSMAN™



**LICENSE PLATE KIT**

» 2873270  
ALL SPORTSMAN™

**PASSENGER HAND WARMERS**

» 2878302  
TOURING 850/1000 MY 15-17

# KEEP IT ICE COLD

Polaris Northstar® coolers can survive just about anything - from extreme heat to a full-on bear attack. Ice will stay cold for hours on end, and anything inside will stay locked up tight.



60 QUART



### POLARIS NORTHSTAR® COOLER

- 60 QUART **SHOWN**  
» 2881259  
SPORTSMAN®, POLARIS ACE®
- 30 QUART  
» 2881315  
ALL POLARIS ACE® MODELS



#### Two Convenient Sizes

30 Quart holds 18 cans  
60 Quart holds 36 cans



#### ComfortCarry Handles

Carry a fully loaded cooler with comfort and ease



#### TravelLock System

Integrated tie-down cleats easily secure to any off-road vehicle, boat or truck



#### EasyOut Drain System

Large, easy to open plug for rapid draining



#### NoSlip Rubber Feet

Firm placement on any surface



#### PolarWall Insulation

Thick 2-inch insulation ensure premium cooling



#### IceLock Seal

Airtight gasket along the lid keeps cold air in

## POLARIS NORTHSTAR® COOLER ACCESSORIES



### WIRE BASKET **NEW**

- 60 QUART **SHOWN**  
» 2882185
- 30 QUART  
» 2882438

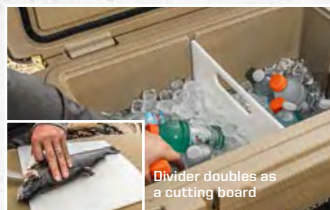

### DIVIDERS **NEW**

- 60 QUART **SHOWN**  
» 2882184  
Comes with two dividers

### 30 QUART

- » 2882186  
Comes with one divider

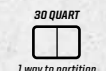

### SEAT CUSHION **NEW** FALL 2016

- 60 QUART **SHOWN**  
» 2882179
- 30 QUART  
» 2882507



### COOLER WHEELS **NEW** FALL 2016

- » 2882180  
60 Quart only



### BOTTLE OPENER **NEW**

- » 2882183  
All Coolers

### LOCK & RIDE® QUICKSTRAP **NEW**

- » 2882187  
All Coolers, RANGER®, Polaris GENERAL®

# SPORTSMAN® BIG BOSS® 6X6



### SPORTSMAN® BIG BOSS® 6X6 LOCK & RIDE® CARGO BOX ADAPTOR KIT

- » 2882302  
SPORTSMAN® BIG BOSS® 6X6 MY17  
Requires (2875176)

### SPORTSMAN® BIG BOSS® 6X6 LOCK & RIDE® GUN BOOT MOUNT ADAPTOR KIT

- Utilize this adaptor kit to add the Lock & Ride® Gun Boot Mount (PN 2879888) onto the 2017 Sportsman® Big Boss® 6x6.
- » 2882257  
SPORTSMAN® BIG BOSS® 6X6 MY17

### SPORTSMAN® BIG BOSS 6X6 PROSPECTOR® PRO TRACK SYSTEM

- Delivers true 3-season performance with more flotation and less maintenance
- Rubber pivot system allows rear axles to move independently for maximum traction
- » 2882169  
BIG BOSS® 570 MY 17  
» 2878421  
BIG BOSS® MY 14-16

### LOCK & RIDE® YUKON ADVENTURE RACK **NEW**

- » 2882084  
BIG BOSS® 570 MY 17



**LOCK & RIDE® WINDSHIELD**

- Strong, durable, protective polycarbonate construction
- Mid-height, 15" tall, for excellent protection and visibility
- Smoke finish with custom Scrambler graphics

» 2879140  
 SCRAMBLER® XP1000 14-17, SCRAMBLER® 850 13-17

# CATCH ME IF YOU CAN

For those that seek the pinnacle of performance, look no further than the Scrambler®. This performance ATV is designed to attack the trails with aggression and confidence.

SCRAMBLER XP® 1000 TITANIUM MATTE METALLIC

**POLARIS**  
**SCRAMBLER®**



**LARGE REAR RACK**

- Strong, durable, lightweight tube construction
- Doubles the usable surface area of the rear rack
- Provides countless tie-down opportunities
- Black wrinkle-coat finish

» 2879139  
 SCRAMBLER® XP 1000 14-17, SCRAMBLER® 850 13-17  
 Not compatible with Ugi® Scrambler® Bag (2879925)

**REAR BASH GUARD**

- Strong, durable, lightweight aluminum construction
- Protects drivetrain at rear of vehicle
- Aggressive racing styling

» 2879138  
 SCRAMBLER® XP 1000 14-17, SCRAMBLER® 850 13-17



**HD WINCHES AND GLACIER® PRO PLOWS**

Page 38 for Winches and Page 40 for Plows and Mounts.



**PROSPECTOR PRO® TRACKS**

Page 48



**WHEELS & TIRES**

Choose your ultimate combination of performance and style. Page 44

**UGIO® SCRAMBLER® BAG**

» 2879925  
 SCRAMBLER® XP 1000 MY 14-17, SCRAMBLER® 850 MY 13-17

**HANDGUARDS**

» 2876846  
 FITS ALL SPORTSMAN® MODELS, REQUIRES MOUNTS (2879380) INSTALLED

**HANDLEBAR HEADLIGHT**

» 2879245  
 SCRAMBLER® XP 1000 MY 14-17, SCRAMBLER® 850 MY 13-17

**BRUSHGUARD**

» 2879136  
 SCRAMBLER® XP 1000 MY 14-17, SCRAMBLER® 850 MY 13-17

**POLARIS® 12" LED LIGHT BAR**

» 2879500  
 SCRAMBLER® FRONT BRUSHGUARD  
**LED LIGHT BAR HARNESS**  
 » 2877910

**POLARIS® HD 3500 LB WINCH**

» 2880435

**POLARIS® HD 2500 LB WINCH**

» 2880433

**WINCH WIRING HARNESS**

» 2879919  
 SCRAMBLER® XP 1000 MY 14-17, SCRAMBLER® 850 MY 13-17,  
 Required to install Polaris® HD Winches



**PRO ARMOR® WHEEL & TIRE SET: REBLR & ATTACK**

» 2881381

**10MM X 1.25 HEX LUG NUTS (16 PACK)**

» 2877384  
 SCRAMBLER® XP 1000 MY 14-17, SCRAMBLER® 850 MY 13-17

**FORGED BEADLOCK RINGS (Qty: 4)**

» VooDoo Blue | 14" | 1522244-619  
 14" BEADLOCK WHEELS ONLY  
 Sold individually. Requires 14" Forged Billet Rings (1522244-133, 1522244-293 or 1522244-589)

**FOX® SUSPENSION**

» 2879258  
 SCRAMBLER® XP 1000 MY 14-17, SCRAMBLER® 850 MY 13-17

**POLARIS**

ENGINEERED PARTS  
ACCESSORIES & APPAREL

# GEAR UP AND GO FORWARD

From the start, all of our accessories are designed, rigorously tested and meticulously fine-tuned to perfectly fit your Polaris ACE. Whether you want to add protection, more storage, or just want that extra edge on the trail, you'll find what you need right here.



POLARIS ACE 570 SP  
TITANIUM MATTE METALLIC

**MAKE AN AWESOME RIDE EVEN BETTER.**

**GREATER CHOICE**  
**NEW FOR 2017**



**NEW LOCK & RIDE HARD COAT POLY FLIP DOWN WINDSHIELD** P.30  
POLARIS ACE 900 XC



**BUMPERS FOR EXTREME PROTECTION** P.34  
POLARIS ACE 900 XC

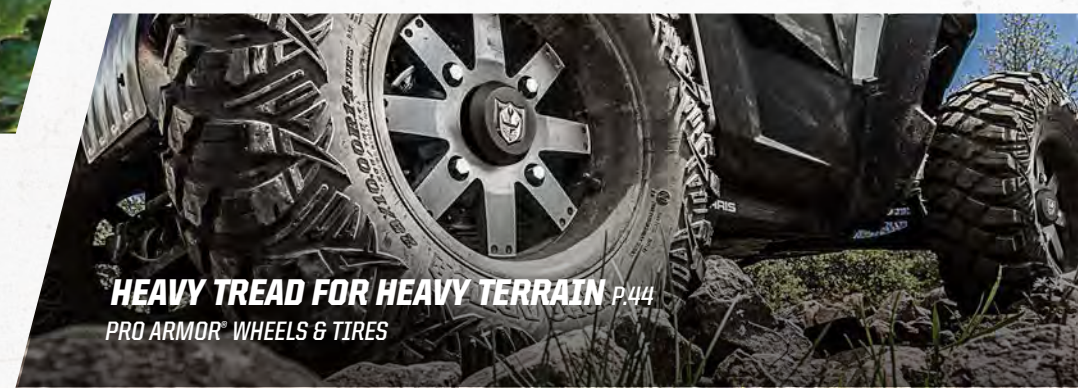

**HEAVY TREAD FOR HEAVY TERRAIN** P.44  
PRO ARMOR WHEELS & TIRES

BUILD YOUR POLARIS ACE BY STARTING WITH THE TOP NEEDS OF OTHER POLARIS ACE OWNERS.

**WINCHES P.38**



**PROTECTION P.34**



**STORAGE SOLUTIONS P.32**



**ROOFS P.30**



**WINDSHIELDS P.30**



**WHEELS & TIRES P.44**



## LOCK & RIDE

An industry exclusive, Polaris Lock & Ride system has revolutionized off-road vehicle customization. Lock & Ride products are specifically designed to be installed quickly and without hassle.

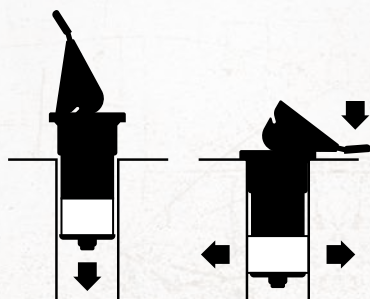

WITH THE FLIP OF A LEVER, LOCK & RIDE PLUNGERS USE DOWNWARD & OUTWARD PRESSURE TO EXPAND FOR A SECURE FIT.

# RIDE BOLDLY ON A NEW PATH

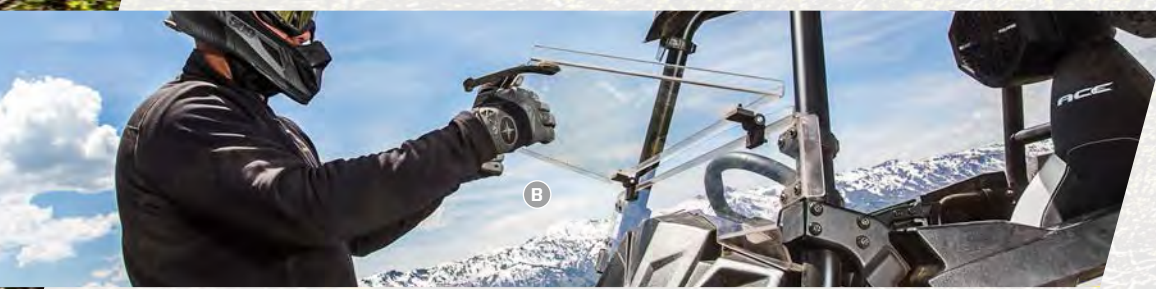

ACE 900 XC MATTE SILVER PEARL

When you're behind the wheel of a Polaris ACE® ripping down the trail, you'll have a feeling of complete independence. Accessorize your machine to enhance your experience with roofs, windshields and lower doors.

**SHOWN WITH:**

- NEW** PRO ARMOR® WHEEL & TIRE SET: A.
- AMPLIFY - ACCENT & CRAWLER XR 28" 2882395 B.
- LOCK & RIDE® HARD COAT POLY FLIP DOWN WINDSHIELD 2882448 C.
- AUDIO PODS 2881227 D.
- XC FRONT BUMPER 2882258 E.
- TOP BUILT** LOCK & RIDE® POLY SPORT ROOF 2881147 F.
- LOWER DOOR EXTENSIONS 2880272 G.
- LOCK & RIDE® CARGO BOX 2881447

# TITAN OF THE TRAIL



Ride with confidence and be prepared for your day off-road. Drop in a Lock & Ride® Rear Cargo Box to haul whatever gear you'll need, and hook up a powerful winch to remove any obstacles along the way.



POLARIS ACE 570 SP  
TITANIUM MATTE METALLIC

#### SHOWN WITH:

- MTX® OVERHEAD AUDIO POD 2879703 A.
- SPARE TIRE MOUNT 2881150 B.
- NEW** FOLDING SIDE MIRRORS 2881517 C.
- TOP SELLER** LOCK & RIDE® POLY SPORT ROOF 2881147 D.
- LOCK & RIDE® MID POLY WINDSHIELD 2879694 E.
- LOWER DOOR EXTENSION 2880272 F.
- PRO ARMOR WHEEL & TIRE SET:  
SIXR - LUSTER & ATTACK 2881359 G.
- POLARIS NORTHSTAR® COOLER - 30 QT 2881315 H.
- REAR ROPS EXTENSION 2881154 I.



## CAB SYSTEM



### CANVAS CAB

- Cab provides riders with protection and enhanced comfort for a more enjoyable riding experience
  - Included are: Canvas roof/rear panel and canvas doors
  - Components can be used to suit rider preference and the day's conditions, i.e., cab can be used without doors attached, etc.
  - Doors and rear panel feature clear plastic windows for excellent visibility
  - Doors feature aluminum frames with durable canvas exterior and durable, reliable hinges and latches
  - Requires the use of accessory Full Poly Windshield (2879693; sold separately)
  - Requires the removal of accessory Polaris Ace® Sport Doors (2879697) if previously installed
- » 2880646  
ALL POLARIS ACE® MODELS

## WINDSHIELDS

### LOCK & RIDE® HARD COAT POLY FLIP DOWN WINDSHIELD **NEW**

LOCK & RIDE

- In its up position, experience full protection from wind, mud, rain or whatever you encounter
  - In the down position, take in the oncoming wind to provide a comfortable and cool in cab environment while the top is securely held in place on the hood
- » 2882443  
ALL POLARIS ACE® MODELS

## ROOFS



LOCK & RIDE

### LOCK & RIDE® POLY SPORT ROOF **TOP SELLER**

- Works with Rear Rops Extender 2881154
- » 2881147  
ALL POLARIS ACE® MODELS



### CANVAS ROOF

- Provides shade and reliable overhead protection from rain and off-road spray
  - Roof attaches securely to vehicle frame using integrated, self-locking mounting hardware
  - Adjustable straps secure rear of roof to vehicle frame
  - Folds for easy, compact storage
- » 2879692  
ALL POLARIS ACE® MODELS



LOCK & RIDE

### LOCK & RIDE® FULL POLY WINDSHIELD **TOP SELLER**

- Windshield is made of impact- and shatter-resistant, 236" polycarbonate with hard coat on both sides
- » 2879693  
ALL POLARIS ACE® MODELS



LOCK & RIDE

### LOCK & RIDE® MID POLY WINDSHIELD

- Provides protection while also allowing airflow to reach the rider
  - Strong, durable, impact-resistant polycarbonate
- » 2879694  
ALL POLARIS ACE® MODELS



LOCK & RIDE

### LOCK & RIDE® SPORT POLY WINDSHIELD

- Distinctive, sporty styling with gradient tint
  - Provides protection and allows airflow to reach the rider
- » 2879695  
ALL POLARIS ACE® MODELS

## DOORS



### A. SPORT DOORS

- Steel frame and strong plastic exterior
  - Premium fit and finish; no cutting, welding or drilling required
  - Add style with custom POLARIS ACE® Sport Door Graphics (sold separately)
- » 2879697  
ALL POLARIS ACE® MODELS

### B. LOWER DOOR EXTENSIONS

- Extensions install on Sport Doors (2879697, sold separately) and create a single, integrated door unit
  - Extensions feature strong, durable steel frame with black hard-plastic exterior
- » 2880272  
ALL POLARIS ACE® MODELS

### SPORT DOOR GRAPHICS

- VELOCITY BLUE 2881610
- INDY RED 2881609
- SAGE GREEN 2881611
- POLARIS ACE®  
Matches MY16 vehicle graphics
- BRIGHT WHITE 2880259
- BLACK PEARL 2880684
- SAGE GREEN 2880685
- VOO DOO BLUE 2880686
- POLARIS ACE®  
Matches MY15 vehicle graphics



### DOOR LINERS

- Durable, weatherproof construction for reliable performance during off-road riding
  - Upper Door Liners feature modest padding to provide passengers with enhanced comfort while riding
  - Liners install easily, attaching to interior door framework
- » 2879431  
ALL POLARIS ACE® MODELS



### POLARIS ACE® LOWER DOOR STORAGE BAGS

- Installs conveniently on inside of accessory lower door, putting storage within easy reach
  - Storage bags mount easily and provide zippered storage spaces for small items
- » 2880455  
ALL POLARIS ACE® MODELS

## REAR PANELS



LOCK & RIDE

### LOCK & RIDE® POLY REAR PANEL

- For best performance, use with a windshield on the vehicle
  - Can be used with other accessories such as roof, cargo bags, etc.
- » 2879696  
POLARIS ACE® MY 14-16, POLARIS ACE® 570 SP MY 15-16, POLARIS ACE® 570 MY 16  
» 2881774  
POLARIS ACE® 900 SP MY 16, POLARIS ACE® 500 MY 17, POLARIS ACE® 570 MY 17, POLARIS ACE® 570 SP MY 17, POLARIS ACE® 900 XC MY 17



### MESH REAR PANEL

- Provides modest shade/dust protection while permitting ventilation and visibility
  - Mounts securely to vehicle frame using adjustable fasteners
  - Install or remove panel quickly and easily without tools
  - Panel folds for easy, compact storage
- » 2879711  
ALL POLARIS ACE® MODELS

# STORAGE

## LOCK & RIDE

### LOCK & RIDE® REAR CARGO BOX

- Installs without tools using twin Lock & Ride® plungers, locks into vehicle's cargo space
- Handles make it easy to carry Cargo Box to and from vehicle
- D-rings on top of box serve as tie-down points for bungees, straps, cargo nets, etc.
- » 2879707
- POLARIS ACE® MY14-16, POLARIS ACE® 570 SP MY15-16, POLARIS ACE® 570 MY16
- » 2881447
- POLARIS ACE® 900 MY 17, POLARIS ACE® 900 SP 16, POLARIS ACE® 570 MY 17, POLARIS ACE® 570 SP MY 17, POLARIS ACE® 900 XC MY 17



### POLARIS ACE® DashPak

- » 2882260
- ALL POLARIS ACE® MODELS



### SIDE BAGS

- Bag has zippered compartment to securely hold cargo and mesh outside pocket
- Sold as a set of 2
- » 2880542
- ALL POLARIS ACE® MODELS, WILL NOT FIT ON MACHINES WITH STOCK OR ACCESSORY DOORS.



### TRAIL BAG

- Securely holds cargo in 4-zippered compartments
- Adjustable Velcro® straps secure bag to vehicle frame
- » 2879705
- ALL POLARIS ACE® MODELS



### OVERHEAD STORAGE BAG

- Securely holds cargo in 3-zippered compartments
- Cargo is easily accessible from driver's seat
- » 2879706
- ALL POLARIS ACE® MODELS



### RIDE & REPAIR ESSENTIALS KIT

- » 2881207
- ALL OFF-ROAD VEHICLES

### REAR ROPS EXTENSION

- Attaches to existing frame for additional protection
- Allows for mounting of accessory Spare Tire Holder (2881150)
- Works with Storage Box and Performance Rear Bumper (2881149)
- » 2881154
- ALL POLARIS ACE® MODELS, EXCEPT 900 XC MY17

### SPARE TIRE MOUNT

- Securely holds spare tire and wheel across top of rear ROPS cage
- » 2881150
- ALL POLARIS ACE® MODELS, EXCEPT 900 XC MY17
- Requires Rear ROPS Extension (2881154)
- Wheel/Tire not included



### SIDE MIRROR **NEW**

- Kit includes left and right mirrors with mounting brackets and hardware
- Hinges feature breakaway design for tight trail conditions and easy trailering
- » 2881517
- ALL POLARIS ACE® MODELS



### LOW PROFILE REAR VIEW MIRROR

- Can be center-mounted on front overhead frame bar, or offset to either side
- » 2880531
- ALL POLARIS ACE® MODELS

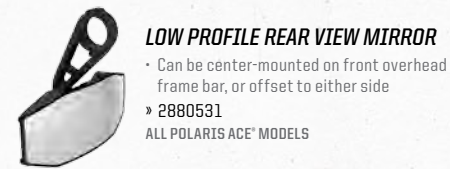

### REAR VIEW MIRROR

- Can be used in conjunction with accessories such as roof, windshield, etc.
- » 2879712
- ALL POLARIS ACE® MODELS



### GUN BOOT MOUNT

- Solid steel frame allows for secure mounting of accessory Polaris® Gun Boot
- » 2881143
- ALL POLARIS ACE® MODELS, EXCEPT 900 XC MY17
- Prohibits use of shifter side door
- Requires Gun Boot (2872677 or 2872677-419)



### POLARIS® GUN BOOTS BY KOLPIN®

- Works with shotgun or rifle
- Padded interior, dust-proof, water-resistant
- » 2872677 | BLACK
- » 2872677-419 | MOSSY OAK®
- ALL POLARIS® GUN BOOT® MOUNTS, EXCEPT KOLPIN® STRONGHOLD®



### HEATED STEERING WHEEL

- » 2881573
- ALL POLARIS ACE® MODELS



### HORN KIT

- » 2879273
- ALL POLARIS ACE® MODELS

# KEEP IT ICE COLD



Polaris Northstar® coolers can survive just about anything - from extreme heat to a full-on bear attack. Ice will stay cold for hours on end, and anything inside will stay locked up tight.



60 QUART



### POLARIS NORTHSTAR® COOLER

- 60 QUART **SHOWN**
- » 2881259
- 30 QUART
- » 2881315



30 quart & 60 quart



ComfortCarry Handles



TravelLock System



EasyOut Drain System



NoSlip Rubber Feet



PolarWall Insulation



IceLock Seal



### BOTTLE OPENER **NEW**

- » 2882183
- All Coolers

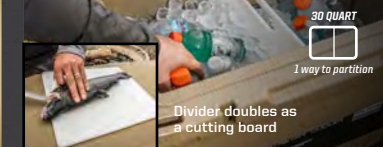

### COOLER DIVIDERS **NEW**

- » 2882184 | 60 qt. **SHOWN**
- » 2882186 | 30 qt.



### WIRE BASKET **NEW**

- » 2882185 | 60 qt. **SHOWN**
- » 2882438 | 30 qt.

## POLARIS NORTHSTAR® COOLER ACCESSORIES



### SEAT CUSHION **NEW FALL 2016**

- 60 QUART **SHOWN**
- » 2882179
- 30 QUART
- » 2882507

### COOLER WHEELS **NEW FALL 2016**

- » 2882180
- 60 Quart only



### LOCK & RIDE® QUICKSTRAP **NEW**

- » 2882187
- All Coolers, Only Fits GENERAL™ & RANGER® Cargo Bed

# PROTECT YOUR RIDE



**EXTREME BRUSHGUARD** TOP SELLER

- Strong 1.25" (3.2cm) diameter steel tube construction with a durable, scratch-resistant black powder-coated finish
- » 2879698 | FRONT  
POLARIS ACE® MY14-16, POLARIS ACE® 570 SP MY15-16, POLARIS ACE® 900 SP MY16
- » 2882504 | FRONT  
POLARIS ACE® 500 MY17, POLARIS ACE® 570 MY17, POLARIS ACE® 570 SP MY17
- » 2879699 | REAR  
ALL POLARIS ACE®, EXCEPT POLARIS ACE® 900 XC



**LOW PROFILE ROCK SLIDERS**

- Low-profile design hugs bodywork to slide over obstacles without compromising ground clearance
- » 2881151  
ALL POLARIS ACE® MODELS, EXCEPT 900 XC MY17  
Expanding Anchor Technology - minimal tools required



**NERF BARS**

- 5" kick-out protects the side of the vehicle acting as a buffer between the vehicle and obstacles
- » 2879700  
ALL ACE® MODELS, EXCEPT 900 XC MY17



**FENDER FLARE KIT**

- Extends bodywork additional 3" for extra protection from mud and water
- » 2879718  
ALL POLARIS ACE® MODELS, EXCEPT 900 XC MY17



**LOW PROFILE BUMPER**

- FRONT / REAR
- Performance inspired, low-profile, steel tube bumper resists direct impacts
- » 2881148 | FRONT  
POLARIS ACE® MY14-16, POLARIS ACE® 570 SP MY15-16, POLARIS ACE® 570 MY16, POLARIS ACE® 900 SP MY16
- » 2881149 | REAR  
POLARIS ACE® MY14-16, POLARIS ACE® 570 SP MY15-16, POLARIS ACE® 570 MY16, POLARIS ACE® 900 SP MY16



**MUD FLAPS**

- Strong, durable plastic Mud Flaps extend beyond edge of front-end bodywork, blocking more mud, spray and debris kicked up by vehicle's front tires
- Works with or without Fender Flares (2879718, sold separately)
- » 2880100  
POLARIS ACE® MY15-16  
Does not work with the Prospector Pro® Track kit

**XC BUMPER** NEW

- » 2882258  
ACE® 900 XC MY17
- » 2882259  
ACE® 900 XC MY17

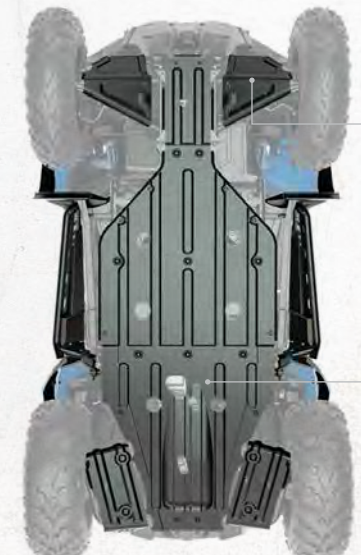

**A-ARM GUARDS**

- HMW polyethylene for strength and low coefficient of friction
- Engineered with drain channels to evacuate water and mud
- » 2879870 | FRONT
- » 2879710 | REAR  
ALL POLARIS ACE® EXCEPT 900 XC MY17 & 570 SP MY17

**SKID PLATE**

- Strong, durable, lightweight 3/8" HMW (high-molecular weight) polyethylene construction
- » 2880543  
ALL POLARIS ACE® MODELS, EXCEPT 900 XC MY17

# RATTLE SOME CAGES

## MTX® OVERHEAD AUDIO POD

- Bluetooth® connectivity for wireless audio
- USB port for charging mobile devices in waterproof storage locker
- LCD display shows audio information; convenient LED lights shine toward rider
- Auxiliary connection through headphone jack
- Dual 6" speakers and tweeters that direct sound toward rider
- Installs in less than 15 minutes; includes all wiring
- Durable, sealed, hard-plastic black housing
- Can be used with a roof and windshield; cannot be used with Overhead Storage Bag

» 2879703  
ALL POLARIS ACE® MODELS



## SOUND BAR 4

- Dual mid-range/mid-bass speaker and two dedicated tweeters
- Integrated, self-powered amplifier for easy installation
- Bluetooth® or wired audio input with variable output
- Large, easy to use external controls
- Aluminum, black finish housing with low profile, clamp-on mounts
- Includes mounts, audio bar, waterproof connections and instructions

» 2881230  
ALL POLARIS ACE® MODELS  
Requires Audio Harness (2881617)



## WATERPROOF BLUETOOTH® AUDIO

- Kit includes four mounting configurations
- Mounts easily to the handlebars, roll cage or fits in your dashboard storage area
- IPX4 rated for water and dust resistance
- Internal LiPo rechargeable battery provides 12 hours of music between charges

» 2880458  
ALL SPORTSMAN®, ALL POLARIS ACE®



## AUDIO PODS

- Two 8" coaxial speakers with 1" titanium tweeters in weatherproof enclosures
- Self-powered 200-watt per speaker output
- Backlit LED illumination selectable between red and blue
- Rotating, low-profile, rubber isolated mounts
- Durable black satin finish

• Required to operate: Head unit or Bluetooth® Remote (2881470)  
» 2881227

ALL POLARIS ACE® MODELS  
Requires Audio Harness (2881617)



## BLUETOOTH® AUDIO REMOTE

- Bluetooth® technology allows you to play music through speakers of choice
- Mount anywhere and control music with easy to use push-button pad

» 2881470  
ALL POLARIS ACE® MODELS



## FRONT BUMPER AUDIO MOUNTING BAR

- Easily mount pod type speakers to your lifted or stock Sportsman®
- Speakers are powered by puck-style Bluetooth® module
- Rear mount doubles as a rack extender and features tie-down locations

» 2881461  
850 SP MY 15-17, 850/XP 1000 HIGH LIFTER EDITION MY 16-17, XP 1000 MY 15-17



## REAR BUMPER AUDIO MOUNTING BAR

- Easily mount pod type speakers to your lifted or stock Sportsman®
- Speakers are powered by puck-style Bluetooth® module
- Rear mount doubles as a rack extender and features tie-down locations

» 2881462  
850 SP 15-17, 850/XP 1000 HIGH LIFTER EDITION 16-17, XP 1000 15-17

# CLEAR THE WAY

Every trail has its obstacles, so every Sportsman® and Polaris ACE® needs a winch to conquer them and keep going. Choose your perfect amount of power and features.



## PRE-WIRED FOR WINCHES

Every Sportsman® comes winch-ready, equipped with factory-installed wiring built into the chassis. Just attach the quick clip connection points and hook up the power cables to the battery, and your winch is powered and ready to go.

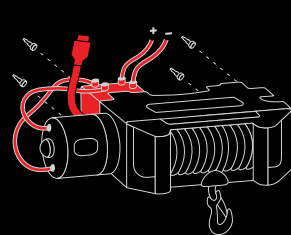

QUALITY ENGINEERED WINCH

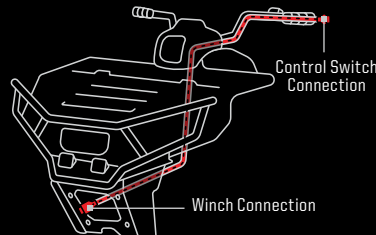

PRE-WIRED CHASSIS

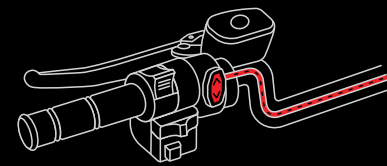

IMPROVED HANDLEBAR CONTROL

### HD HEAVY DUTY SERIES 3500 LB. WINCH



**POLARIS® HD 3500 LB WINCH**  
 • 1-year warranty  
 » 2879709  
 POLARIS ACE® MY 14-16, POLARIS ACE® 570 SP MY 15-16, POLARIS ACE® 570 MY 16, POLARIS ACE® 900 SPMY 16  
 » 2882106  
 POLARIS ACE® 500 MY 17, POLARIS ACE® 570 MY 17, POLARIS ACE® 570 SP MY 17, POLARIS ACE® 900 XC MY 17

» 2880434 **TOP SELLER**  
 570 MY 14-17, 570 SP MY 15-17, 570 X2 MY 15-17, 570 X2 SP MY 16, TOURING 570 MY 14-17, ETX MY 15, 450 H.O. MY 16-17  
 » 2880435 **TOP SELLER**  
 850 SP MY 15-17, 850/XP 1000 HIGH LIFTER EDITION MY 16-17, XP 1000 MY 15-17, SCRAMBLER® XP 1000 MY 14-17, TOURING XP 1000 MY 15-17, 550/850 MY 09-17

#### HEAVY-DUTY PULLING POWER

- Cut steel gears for improved durability
- Steel spool can handle extreme loads
- 40% quieter – near-silent free spooling
- Sealed motor and drivetrain
- Low-voltage contactor
- Integrated wiring and mount plates ensure perfect fit

**7** OUT OF **10**  
**RIDERS EQUIP THEIR MACHINE WITH A WINCH**

### HD HEAVY DUTY SERIES 2500 LB. WINCH



**POLARIS® HD 2500 LB WINCH**  
 • 1-year warranty  
 » 2879708  
 POLARIS ACE® MY 14-16, POLARIS ACE® 570 SP MY 15-16, POLARIS ACE® 570 MY 16, POLARIS ACE® 900 SP MY 16  
 » 2882105  
 POLARIS ACE® 500 MY 17, POLARIS ACE® 570 MY 17, POLARIS ACE® 570 SP MY 17, POLARIS ACE® 900 XC MY 17

» 2880432 **TOP SELLER**  
 570 MY 14-17, 570 SP MY 15-17, 570 X2 MY 15-17, 570 X2 SP MY 16, TOURING 570 MY 14-17, ETX MY 15, 450 H.O. MY 16-17  
 » 2880433 **TOP SELLER**  
 850 SP MY 15-17, 850/XP 1000 HIGH LIFTER EDITION MY 16-17, XP 1000 MY 15-17, SCRAMBLER® XP 1000 MY 14-17, TOURING XP 1000 MY 15-17, 550/850 MY 09-17

## UPGRADE YOUR POLARIS® WINCH WITH THESE ACCESSORIES



**POLARIS® AUTO-STOP WINCH UPGRADE KIT**  
 • Requires use of synthetic cable rope (not included)  
 » 2879149  
 POLARIS® HD 2500 & 3500 LB. WINCHES



**SYNTHETIC WINCH ROPE**  
 » 2878888  
 POLARIS® HD 2500 & 3500 LB. WINCHES



**POLARIS® WIRELESS WINCH REMOTE**  
 » 2879316  
 ALL SPORTSMAN® & POLARIS ACE® WINCHES

# PUSH FORWARD

When you have the power of a Glacier® Pro Plow System on your machine, you can truly take command of clearing snow and moving what ever you need to. Find the blade that fits your needs and you'll make quick work of even the heaviest jobs.



## 1 SELECT A MOUNT

### INTEGRATED PLOW MOUNT FRAME ATTACHMENT

• Fits all current Glacier® Pro Plow System components

» 2879634

ALL ACE® MODELS MY 16 AND OLDER, EXCEPT 900 SP MY16

» 2881423

850 SP 15-17, 850/XP 1000 HIGH LIFTER EDITION 16-17, XP 1000 15-17, TOURING XP 1000 15-17

» 2881424 **TOP SELLER**

570/450 15-17, 570 SP MY 15-17, 570 X2 MY 15-17, 570 X2 SP MY 16, TOURING 570 MY 15-17

» 2882107 **NI-VI**

ALL POLARIS ACE® MY 17, POLARIS ACE 900 SP MY 16

### POWER CONTROLLER

• Allows the rider to control plow angle and blade height from inside the cab

» 2880836

ALL POLARIS ACE® MODELS



## 2 SELECT A FRAME

### PLOW FRAME **TOP SELLER**

- Heavy-duty steel frame
- Installs on the plow blade of your choice (each sold separately)
- Includes complete Glacier® Pro Plow Frame

» 2879630

ALL SPORTSMAN® & POLARIS ACE® MODELS

### GLACIER® PRO PLOW HYDRAULIC ANGLE SYSTEM

- Angle your plow blade with the push of a button so you can clear more snow or other material

» 2879635

ALL SPORTSMAN® & POLARIS ACE® MODELS  
Power Controller Required (2880836)

## 3 SELECT A WINCH

### POLARIS® PRO HD 3500 LB. WINCH

### POLARIS® HD 2500 LB. WINCH

See page 38.

### PLOW WINCH ROPE

- Improved durability for plow use vs. steel cable
- Thicker than standard synthetic rope
- 8' (2.4m) of 0.25" (6mm) braided rope

» 2878483

POLARIS® HD 2500 & 3500 LB. WINCHES

## 4 SELECT A BLADE

### GLACIER® PRO PLOW 66" POLY BLADE

- Polyethylene prevents snow build up
- Requires plow blade frame for mounting (sold separately)
- Includes plow blade and metal wear bar

» 2880269

### GLACIER® PRO PLOW STEEL BLADES **TOP SELLER**

- Requires plow blade frame for mounting (sold separately)
- Includes plow blade and metal wear bar

» 2879638 | 60"

» 2879639 | 52"

# GLACIER® PRO PLOW SYSTEM



TAKE ON THE SNOW WITH THE NEW PRO ARMOR® WHITEOUT TIRES

## DOES YOUR VEHICLE HAVE TRACKS?

### GLACIER® PRO PLOW EXTENSION

» 2879719

ALL GLACIER® PRO ATV PLOW MOUNTS

Plow Extension for use when using the Prospector Pro® Track System



## SELECT ACCESSORIES

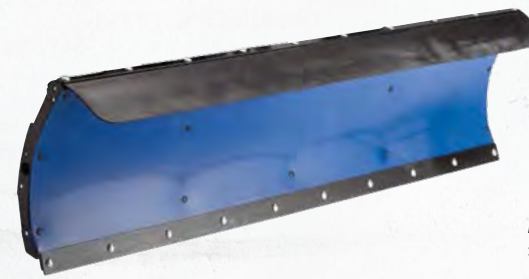

### PLOW BLADE SNOW DEFLECTOR

» 2879866 | 66"



### PLOW MARKER

- Helps driver monitor plow blade position
- Sold in pairs

» 2872726



### REAR TIRE CHAINS

- Sold in pairs

» 2881442

» 2881422

FITS 25" & 26" TIRES



### STANDARD WEAR BARS

- Protect your plow blade and minimize wear on the actual blade by installing Wear Bars

» 2879867 | 66"

FITS PLOW BLADE 2879637 FOR SPORTSMAN® & POLARIS ACE®

» 2871806 | 60"

FITS PLOW BLADE 2879638 FOR SPORTSMAN® & POLARIS ACE®

» 2877210 | 52"

FITS PLOW BLADE 2879639 FOR SPORTSMAN® & POLARIS ACE®

### QUICK RELEASE SKID SHOES

- Help prevent blade wear
- Hardened steel for industrial strength

» 2205071

FITS PLOW BLADES 2879637, 2879638, 2879639 FOR SPORTSMAN® & POLARIS ACE®

### COIL SPRING SPACER

- Keep the front end of the vehicle up and improve ride quality when using a plow on strut or a-arm vehicles

» 2872655

### FRONT SPRING PRE-LOAD ADJUSTERS

- Keep the front end of the vehicle up and improve ride quality when using a plow and a strut model machine.

» 2876463

SPORTSMAN® 450/570 NON-SP

### SHEAR PIN REPLACEMENT (NOT SHOWN)

- Direct replacement for a Glacier® Pro ATV Plow System Shear Pin

» 2205063

# LIGHT THE WAY

Stay out longer with the help of our powerful and technologically superior lighting systems. When you're looking to take your lighting to the next level, look no further than Polaris®.

## POLARIS ENGINEERED™

Designed, built and tested with your Sportsman® or Polaris ACE®, Polaris Engineered™ lights feature some of the most advanced heat management options and unmatched durability for the off-road.

### REFINED DESIGN

Constructed with a shatterproof polycarbonate lens and ultra durable, high grade 6061 aluminum housing. Sealed to be dust tight and water tight. Fully submersible up to one meter.

### ADVANCED TECH

Next generation 10 Watt LED and drivers maximize LED efficiency (90% for 860 lumen output per LED) producing more light per watt. LED last up to 50,000 hours.

### EXCLUSIVE OPTICS

Precisely angled reflectors provide the function of two lights in one by flooding light for an extreme distance both down and across your range of view.



13"



12"



CANNON

### ACCENT LIGHTING KIT

- Set includes 4 LED pods
- Durable off-road ready construction that is both dust and water-resistant
- » 2880500 | RED
- » 2880506 | BLUE
- » 2881119 | WHITE
- » 2882379 | GREEN (Not shown)
- ALL POLARIS ACE®

### SINGLE ACCENT LIGHT

- Durable off-road ready construction that is both dust and water-resistant
- Features CREE LED for a long lasting brilliant light
- Control hub and complete instructions included
- » 2880532 | RED
- » 2880533 | BLUE
- » 2881176 | WHITE
- » 2882378 | GREEN **NEW**
- (Not shown)
- ALL POLARIS ACE®

### LED LIGHT BARS

- 13" or 12" LED Light Bar elevates the vehicle's sporty, high-performance style
- Installs quickly and easily into designated mounting locations and connects to vehicle's electrical system
- Dustproof and waterproof up to one meter; tested to IP67 standards

### 13" LED LIGHT BAR

- 3168 Lumens value
- » 2880530
- ALL SPORTSMAN®, ALL POLARIS ACE®

### 12" LED LIGHT BAR

- 2100 Lumens value
- » 2879500
- ALL SPORTSMAN®, ALL POLARIS ACE®

### CANNON LIGHT

- 4" bullet style light
- Durable housing protects lights from rocks and debris
- Includes single 4" light, mount, clear euro cover, amber euro cover and amber spot cover
- 1052 Lumens value
- » 2881471
- ALL SPORTSMAN®, ALL POLARIS ACE®

### 2" LED LIGHT

- 900 Lumens value
- » 2878715
- ALL SPORTSMAN®, ALL POLARIS ACE®

### RALLY LIGHT

- 4" lens with 35-watt halogen bulb
- » 2877335
- ALL SPORTSMAN®, ALL POLARIS ACE®

### BLUE XENON HEADLIGHT BULBS

- Over 50% brighter than stock bulbs
- » 2876464
- XP MY 09-14, SPORTSMAN® MY 05-14

### ADJUSTABLE ALUMINUM BILLET CLAMPS

- Adjustable to fit either 1.5" or 1.75" tubing
- » 2878798
- ALL SPORTSMAN®, ALL POLARIS ACE®

### BILLET CLAMP

- » 2878906
- ALL SPORTSMAN®, ALL POLARIS ACE®

## WIRING HARNESSES

- UNIVERSAL LED LIGHTBAR HARNESS
- » 2879863
- ALL SPORTSMAN®

# WHEELS & TIRES



## PRO ARMOR

Conquer any terrain with Pro Armor® tires. Pro Armor® delivers purpose built tires with superior durability and ultimate performance for the environment you ride. Not only that, but they're developed and tested with Polaris Engineers—ensuring the perfect fit and optimal performance mile-after-mile.

# FULL TREAD TO CONQUER ANY TERRAIN

### KNOW YOUR TIRES

**TREAD DEPTH**  
More grip and clean performance

**WEIGHT**  
The lighter the better vehicle performance

**PLY RATING**  
Ply rating indicates the overall load capability of a tire.

**SIDEWALL BELTS**  
The more you have the better resistance to sidewall punctures

**LOAD RATING**  
How much weight the tires can take

**PADDLES**  
Specific to sand tires, the more you have the greater the traction

**PADDLE HEIGHT**  
More grip and clean performance for sand

## TIRES



### UTILITY

**5,000+ MILES OF TREAD LIFE**



#### PRO ARMOR HARVESTER **NEW**

All-around work horse with tread life of 5,000 miles.

- Tread pattern designed to withstand anything from the farm yard to the pastures to the trail
- With 10-Ply it can carry the load day-in and day-out

FRONT/REAR	FRONT/REAR
26" x 10" R12	27" x 10" R14
5415966	5415965

	TREAD DEPTH	WEIGHT	PLY RATING	SIDEWALL BELTS	LOAD RATING
26R12	16 mm	32 lbs	10	3	1,320 lbs
27R14					

26R12 ONLY FITS SPORTSMAN 570SP

**EXTREME KEVLAR PROTECTION**



#### PRO ARMOR XD-K

Confidence for any challenging terrain - it's Kevlar®

- Aggressive lugs to help grip the terrain without worrying about punctures
- Kevlar belt wraps from bead to bead for full coverage

FRONT	REAR
26" x 9" R12	26" x 11" R12
5415756	5415757

	TREAD DEPTH	WEIGHT	PLY RATING	SIDEWALL BELTS	LOAD RATING
FRONT	31.7mm	38 lbs	8	3/1 KEVLAR	935 lbs
REAR		40 lbs			1,100 lbs

### ROCK/DESERT



#### PRO ARMOR CRAWLER XR 28"

This tire grips it all from the trail to the rocks

- Square block profile for even surface contact.
- A tougher durometer than the XG to take on the toughest the trail has to offer
- Combination square block profile and soft durometer tread design

FRONT	REAR
28" x 10" R14	28" x 10" R14
5415536	5415536

	TREAD DEPTH	WEIGHT	PLY RATING	SIDEWALL BELTS	LOAD RATING
FRONT	13.5 mm	32 lbs	8	3	1,140 lbs
REAR					

ONLY FITS POLARIS ACE 900 XC

### BUILT TO PERFORM

Triple belt sidewalls provide superior durability and resistance to sidewall punctures while increasing load ratings – all without adding weight for optimal performance.

BACKED BY **1 YR WARRANTY**



**3 SIDEWALL BELTS**  
**8 PLY RATING**



### READING TIRES NUMBER BY NUMBER

28" x 9" R14  
Tire Height    Tire Width    Wheel Size

### SAND



#### PRO ARMOR DUNES

28" Flotation across the dunes.

- Lightweight 12-paddle rear tires tout a flexible sidewall for flotation and acceleration
- Three-tiered front tire design delivers hard turning bite and straight-line tracking

FRONT	REAR
28" x 9" R14	28" x 11" R14
5415533	5415534

	PADDLE DEPTH	WEIGHT	PLY RATING	SIDEWALL BELTS	LOAD RATING
FRONT	12.8mm	20 lbs	8	2	635 lbs
REAR	31mm				965 lbs

ONLY FITS POLARIS ACE 900 XC

### SNOW



#### PRO ARMOR WHITEOUT **NEW**

Extra wide tires for flotation in snow.

- Tread pattern designed for superior snow traction with limited digging

FRONT	REAR
27" x 14" R14	27" x 14" R14
5416032	5416032

	TREAD DEPTH	WEIGHT	PLY RATING	SIDEWALL BELTS	LOAD RATING
FRONT	16 mm	24 lbs	8	2	935 lbs
REAR					

### MUD



#### PRO ARMOR DAGGER

From the trails to the pits, this specialist gets you through it all.

- Deep, self-cleaning lug and wide tire design for exceptional mud pit performance
- Rounded profile and full lug pattern for on-trail comfort

FRONT	REAR
27" x 9" R14	27" x 11" R14
5415617	5415618

	TREAD DEPTH	WEIGHT	PLY RATING	SIDEWALL BELTS	LOAD RATING
FRONT	38mm	36 lbs	8	3	1,100 lbs
REAR		40 lbs			1,170 lbs

### MUD



#### PRO ARMOR ANARCHY

Take on any mud pit with the mud master

- Ultra deep lugs for maximum mud traction. Deep, evenly spaced out lugs help channel the muck out so they can keep going
- Deep sidewall tread delivers added bite in off-camber positions

FRONT	REAR
29.5" x 9" R14	29.5" x 9" R14
5415535	5415535

	TREAD DEPTH	WEIGHT	PLY RATING	SIDEWALL BELTS	LOAD RATING
FRONT	52 mm	40 lbs	8	3	1,170 lbs
REAR					

ONLY FITS SPORTSMAN® HIGH LIFTER EDITION MODELS

### TRAIL



#### PRO ARMOR ATTACK

The best all-purpose tire for all season traction in any terrain.

- Unique full-face tread design
- Harder durometer lugs promote extended wear, increasing tire life

FRONT	REAR
26" x 9" R14	26" x 11" R14
5415613	5415614

	TREAD DEPTH	WEIGHT	PLY RATING	SIDEWALL BELTS	LOAD RATING
FRONT	23mm	28 lbs	8	3	910 lbs
REAR		32 lbs			1,320 lbs



# WHEELS & TIRES

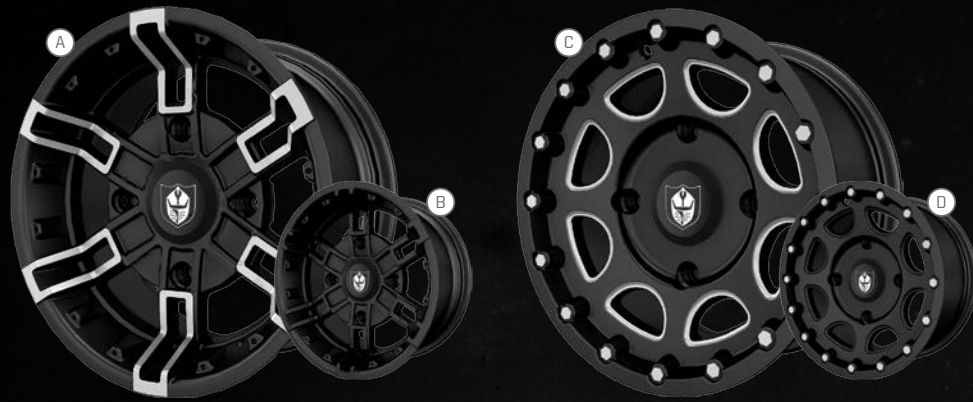

### A. BUCKLE ACCENT

Front 14" x 7" | 1522544-266  
Rear 14" x 8" | 1522545-266

### B. BUCKLE MATTE BLACK

Front 14" x 7" | 1522544-458  
Rear 14" x 8" | 1522545-458

### C. SHACKLE ACCENT

Front 14" x 7" | 1522546-266  
Rear 14" x 8" | 1522547-266

### D. SHACKLE MATTE BLACK

Front 14" x 7" | 1522546-458  
Rear 14" x 8" | 1522547-458

### E. SPLIT MATTE BLACK

Front 14" x 6" | 1522542-458  
Rear 14" x 8" | 1522543-458

### F. SIXR MATTE BLACK

Front 14" x 7" | 1521507-521  
Rear 14" x 8" | 1521508-521

### G. SIXR LUSTER

Front 14" x 7" | 1521507-410  
Rear 14" x 8" | 1521508-410

### H. SIXR MACHINED

Front 14" x 7" | 1521507-266  
Rear 14" x 8" | 1521508-266

### I. REBLR BLACK

(REQUIRES BEADLOCK RINGS)  
Front 14" x 7" | 1522238-458  
Rear 14" x 8" | 1522239-458

### J. AMPLIFY ACCENT **NEW**

Front 14" x 7" | 1522956-266  
Rear 14" x 8" | 1522957-266

### K. AMPLIFY MATTE BLACK **NEW**

Front 14" x 7" | 1522956-458  
Rear 14" x 8" | 1522957-458

### L. THRASHER LUSTER

Front 14" x 6" | 1522241-410  
Rear 14" x 8" | 1522242-410

SPORTSMAN® 850/1000 MY15-17

### M. THRASHER MATTE BLACK

Front 14" x 6" | 1522241-458  
Rear 14" x 8" | 1522242-458

SPORTSMAN® 850/1000 MY15-17

### N. WHITEOUT MATTE BLACK **NEW**

14" x 10" | 1522958



### BEADLOCK RINGS

**Voodoo Blue**  
14" | 1522244-619

**Machined**  
14" | 1522244-266

**White**  
14" | 1522244-133

**Indy Red**  
14" | 1522244-293

**Orange Crush**  
14" | 1522244-589

ONLY USED ON REBLR WHEELS.  
14" BEADLOCK RINGS,  
SOLD INDIVIDUALLY

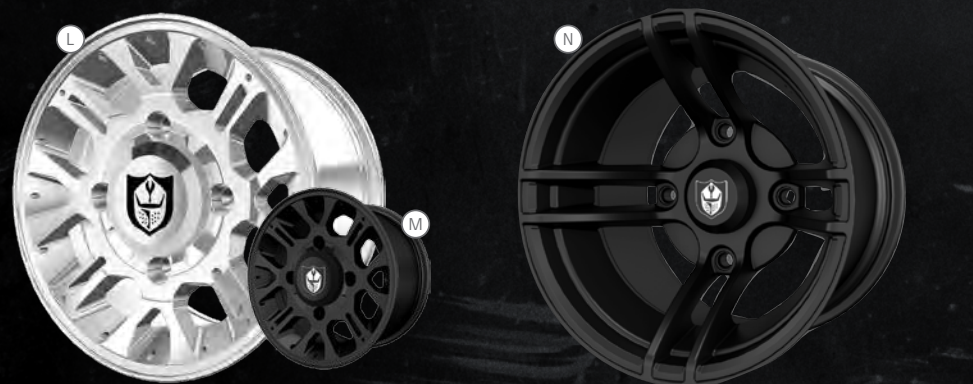

## TIRE & WHEEL SETS (4 WHEELS PER SET)

Using your tire and wheel selection, select your set and order by visiting your local Polaris® dealer or learn more at [Polaris.com](http://Polaris.com).

	CRAWLER XR ACE 900 XC	ATTACK ALL SPORTSMAN® 6 ACE™ MODELS	DUNES ACE 900 XC	ANARCHY SPORTSMAN® 850 6 XP 1000 HIGH LIFTER EDITIONS	DAGGER ALL SPORTSMAN® 6 ACE™ MODELS	HARVESTER 27R14 ALL SPORTSMAN® 6 ACE™ MODELS	WHITEOUT ALL SPORTSMAN® 6 ACE™ MODELS
<b>PRO ARMOR® WHEELS</b>							
AMPLIFY Accent	2882395	2882390	2882401	2882403	2882393	2882388	
AMPLIFY Matte Black	2882394	2882391	2882400	2882402	2882392	2882389	
BUCKLE Accent	2881343	2881335	2881345	2881341	2881337	2882383	
BUCKLE Matte Black	2881344	2881336	2881346	2881342	2881338	2882384	
SHACKLE Accent	2881355	2881347	2881357	2881353	2881349	2882385	
SHACKLE Matte Black	2881356	2881348	2881358	2881354	2881350	2882386	
SIXR Luster	2881371	2881359	2881374	2881368	2881362		
SIXR Matte Black	2881372	2881360	2881375	2881369	2881363	2882387	
SIXR Machined	2881373	2881361	2881376	2881370	2881364		
THRASHER Luster (Only Fits Sportsman® 850, 850 SP 6 XP 1000)		2881377		2881445	2881379		
THRASHER Matte Black (Only Fits Sportsman® 850, 850 SP 6 XP 1000)		2881378		2881446	2881380		
REBLR Matte Black	2881386	2881381	2881387	2881385	2881383		
SPLIT Matte Black		2881404	2881407		2881405		
WHITEOUT Matte Black							2882382

## LUGS



### 10MM X 1.25 HEX LUG NUTS

» 2877385 | 4 HEX LUG NUTS  
» 2877384 | 16 HEX LUG NUTS  
SPORTSMAN® 850, 850 6 1000 MODELS,  
ALL SPORTSMAN XP™ MODELS

### 3/8" - 24 HEX LUG NUTS

» 2876754 | 4 HEX LUG NUTS  
» 2877409 | 16 HEX LUG NUTS  
ALL ACE™ MODELS, SPORTSMAN® 570/450 H.O. MODELS,  
ALL SPORTSMAN® NON-XP MODELS

## REPLACEMENT CAPS



### POLARIS® CAPS

» 1521509-410 | Luster  
» 1521509-521 | Matte Black  
AMPLIFY, BUCKLE, REBLR, SHACKLE, SIXR, SPLIT, WHITEOUT  
» 1522243-410 | Luster  
» 1522243-458 | Matte Black  
THRASHER

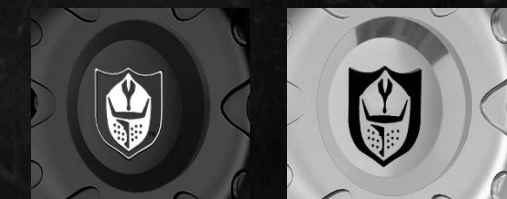

### PRO ARMOR® CAPS

» 5453209-410 | Luster  
» 5453209-458 | Matte Black  
AMPLIFY, BUCKLE, REBLR, SHACKLE, SIXR, SPLIT, WHITEOUT, WYDE  
» 1523015-410 | Luster  
» 1523015-458 | Matte Black  
THRASHER



# ALL-TERRAIN TRACTION

It's tough to make Sportsman® and Polaris ACE® even more versatile than they already are. But with a set of Prospector Pro® Tracks, you'll do just that. Tread through deep snow without concern.



Exclusive 20-18 tooth gear ratio optimized for Polaris® drivetrain (specific models).



Heavy-duty, wide, rubberized wheels on a UHMW base to distribute the weight of the side-by-side



## BIG BOSS® 6X6 TRACK KIT **NEW**

- » 2882169
- BIG BOSS® 570 MY 17
- » 2878421
- BIG BOSS®-800 MY 14

## 1 SELECT A MOUNT

### PROSPECTOR PRO® MOUNT

- Dual bogie wheels manage weight properly & deliver a great ride & outstanding traction in snow
- High Clearance Track Mount Kit
- Track sold separately
- » 2879457
- 550/850/1000 MY 09-16, TOURING 550/850/1000 MY 10-17, X2 550/850 10-14, SCRAMBLER® 850/1000 MY 13-17, 850/850 SP MY 17
- » 2882109 **NEW**
- XP 1000 MY 17
- » 2879497
- 570 MY 14-15, ETX MY 15, 570 TOURING MY 14-15, 570 X2 MY 15, 450 H.O. MY 16-17, 500/600/700/800 MY 05-14
- » 2880072
- X2 500/800 MY 08-14, TOURING 500/800 MY 08-14
- » 2879751
- POLARIS ACE® MY 14-16, POLARIS ACE® 500 MY 17, POLARIS ACE® 570 SP MY 15-16, POLARIS ACE® 570 MY 16-17, POLARIS ACE® 900 SP MY 16

## 2 SELECT A KIT

### PROSPECTOR PRO® TRACKS

- They deliver the best in performance, reliability, durability and value in every season.
- Polaris® track systems deliver the utmost in performance and productivity, with absolutely no compromise of vehicle cargo capacity or pulling power.
- » 2881003
- 850 MY 13-15, 550/850 (NON SP) MY 09-17, 550/850 TOURING MY 09-14, X2 550/850 MY 10-14, XP 1000 (NON EPS) MY 16
- » 2881025
- SPORTSMAN® 570 SP, TOURING 570 SP, X2 570 EPS, POLARIS ACE® 570 SP MY 15-16, POLARIS ACE® 900 XC MY 17
- » 2880020
- SPORTSMAN® 570 MY 14 (NON SP), SPORTSMAN® 570 TOURING MY 14 (NON SP), SPORTSMAN® 570 TOURING EPS (NON SP), SPORTSMAN® ETX MY 15, SPORTSMAN® 450 H.O. MY 16-17, POLARIS ACE® MY 14-16, POLARIS ACE® 500 MY 17, POLARIS ACE® 570 MY 16-17

# POLARIS® INTERACTIVE DIGITAL DISPLAY 2.0



1. Speedometer
2. Real-Time Clock
3. Compass
4. Tachometer
5. Coolant Temperature
6. Gear Position
7. Odometer Trip Meter
8. Fuel Level Indicator
9. 4x4 Indicator



GPS connectivity offers exact location information including elevation, latitude/longitude and compass bearings

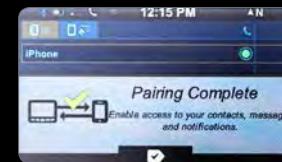

Bluetooth® functionality allows you to see your missed calls and text messages on the display



TPS, RPM and ground speed playback for up to 1:30 seconds to easily change clutching specifications

### NEW FEATURES

- Control of Bluetooth® audio media streaming with track and artist display
- Backup camera display (If enabled and supported by hardware, will be shown when shifting to reverse.)
- Forward camera display (If enabled and supported by hardware, will be added to the main screens when cycling using the far left button)
- Exporting capabilities for created tracks and waypoints from the display to USB drive
- Course up arrow option with rotating background map now available
- Distance to a selected waypoint shown on the map screen
- Automatic day/night brightness change based on time of day and day of year
- New riding screen with increased visibility to important diagnostics, gear indicator enlarges on gear change

### STANDARD FEATURES

- High resolution, 4.3" full color LCD display
- Bluetooth® connectivity allows you to pair your smart phone and check missed calls, text message, battery life and signal strength
- Diagnostics screen displays vehicle fault codes (NEW: Voltage and engine temp faults will pop up and turn red at critical levels)
- GPS Connectivity offers exact location information including elevation, latitude/longitude and compass bearings
- » 2881554
- POLARIS ACE®
- Must purchase Sportsman® Install Kit (2880536)

### POLARIS® INTERACTIVE DIGITAL DISPLAY INSTALL KIT

- Includes all installation hardware and harnesses
- » 2880537
- SPORTSMAN® XP 1000 MY 15-16, SPORTSMAN® 570 SP MY 15-17, ALL POLARIS ACE® MODELS

### XP POLARIS® INTERACTIVE DIGITAL DISPLAY INSTALL KIT **NEW**

- P100 Install Kit
- » 2882275
- ALL POLARIS ACE® MODELS

### QUICKTAP BATTERY POSTS

- Easy to access terminal posts give you quick access to the battery power.
- Ideal for charging your battery, powering a temporary accessory or when you need to offer an unexpected jump-start.
- Connection posts feature covers to protect terminals when not in use.
- » 2882110
- ETX MY 15, 450 H.O. MY 16-17, 570 MY 14-17, 570 SP MY 15-17, 570 X2 MY 15-17, 570 X2 SP MY 16, TOURING 570 MY 14-17

# STOCK YOUR GARAGE

FOR THE LIFE OF YOUR RIDE

POLARIS® PS-4 VS AUTOMOTIVE OIL

When your Sportsman® or Polaris ACE® demands the very best, look no further than PS-4 oil from Polaris®. Engineered for wear protection, PS-4 gives you the power to keep riding in any condition.

**39%**  
GREATER VISCOSITY RANGE

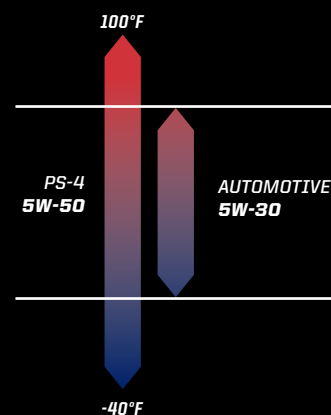

- Industry-leading viscosity range
- 5W provides optimal cold-start protection
- 50 provides maximum film strength in high-heat, high-stress conditions

**24%**  
BETTER WEAR PROTECTION



- Anti-wear additives bond to critical motor internals for wear prevention
- High detergency prevents sludge and carbon buildup

**19%**  
HIGHER OIL RETENTION



- Full synthetic base stock
- Low volatility keeps oil in the crankcase



PS-4 OIL CHANGE KIT  
» 2879323



PS-4 EXTREME DUTY OIL CHANGE KIT  
» 2879324



ORV MAINTENANCE KIT  
» 2880425



PS-4 EXTREME DUTY - 1 QUART  
» 2878920



PS-4 - GALLON  
» 2876245

PS-4 EXTREME DUTY - GALLON  
» 2878919

## TOP 3 MAINTENANCE TIPS

1. CHANGE ENGINE OIL EVERY 100 HOURS OR 6 MONTHS WITH PS-4 OR PS-4 EXTREME DUTY

\*\*\*PERFORM BREAK-IN OIL CHANGE AT 25 HOURS

2. CHANGE DRIVE TRAIN FLUID EVERY 100 HOURS OR 12 MONTHS WITH THE ORV MAINTENANCE KIT, PER VEHICLE MANUAL

3. VISUALLY INSPECT COOLANT, FUEL FILTER, AIR FILTER AND BELTS REGULARLY.

FOR MORE INFORMATION AND PRODUCTS VISIT: [POLARISLUBRICANTS.COM](http://POLARISLUBRICANTS.COM)

# FOR THE LIFE OF YOUR RIDE

Polaris Engineered Parts™ are rigorously tested, developed specially for your machine and optimized for peak performance. Everything from parts and lubricants, to tool chests and generators—Polaris® has all of the highest-quality products to keep your off-road vehicle running at peak performance.

CHECK OUT OUR [PARTS FINDER ON POLARIS.COM](https://www.polaris.com/parts-finder) FOR EASY PARTS LOOK-UP, PARTS IDENTIFICATION, VIEWS OF ASSEMBLIES AND MORE!

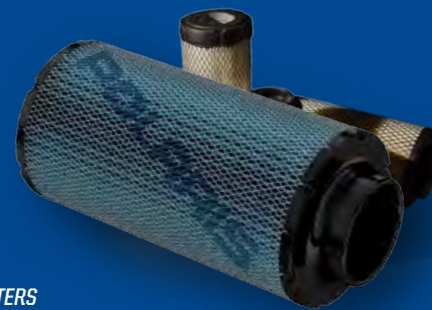

### AIR FILTERS

- In extreme stress tests, blocked over 99.95% of dust and contaminants



### OIL FILTERS

- Designed to keep strong oil flow in the most demanding conditions
- Allows optimal oil flow for cold starts



### BATTERY

- Dependable and purpose-built for the off-road, so you know it's ready to go when you are
- Made in U.S.A.



### BRAKE PADS

- Designed and tested to perform in all conditions: humid, wet or dry, hot or cold
- Features sintered metallic pads to ensure optimal performance at extreme operating temperatures
- Engineered for maximum output and minimal noise and wear



### DRIVE BELTS

- Lowest tolerance available (.188") means our belts have the least variation allowed in width and length, resulting in consistently higher performance
- All belts undergo at least 20,000 miles of vehicle testing and 1,500 hours of runtime in a dynamometer

## RAMPS

### ALUMINUM ARCHED LOADING RAMPS

- » 2875384 | 76" x 12"

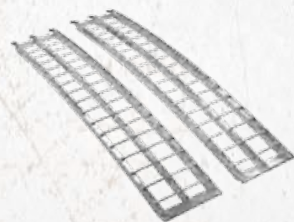

### FOLDING HEAVY-DUTY ALUMINUM RAMPS

- » 2875387 | 76" x 12"



### LIGHTWEIGHT TRI-FOLD RAMPS

- » 2875385 | 76" x 51"

## COVERS



### TRAILERING COVER

- » 2876614 ALL SPORTSMAN® (EXCEPT 300/400, X2, SPORTSMAN™ TOURING)
- » 2877999 ALL SPORTSMAN™ TOURING
- » 2877998 SPORTSMAN™ X2
- » 2880056 ALL POLARIS ACE™ MODELS

## CLEANING PRODUCTS

### PRE-TREAT

- MUD SHIELD™ PRE TREATMENT
- » 2830208

- NEVER RUST SPRAY™
- » 2830209

### CLEAN

- XP WASH™
- » 2830203

- XP SPRAY WASH™
- » 2830202

- GLASS CLEANER
- » 2830439

### CLEAN

- ALL PURPOSE CLEANER
- » 2830205 | 16 oz.

- HD CLEANER & DEGREASER
- » 2830418 | 1 gal.
- » 2830420 | 5 gal.

- VEHICLE & EQUIPMENT WASH
- » 2830417 | 1 gal.
- » 2830422 | 5 gal.

- ALL PURPOSE CLEANER PLUS
- » 2830414 | 1 gal.
- » 2830416 | 5 gal.

### SHINE

- SHINE POLARIS® POLISH
- » 2830207

- INSTANT SHINE & DETAILER
- » 2830204



## BATTERY CARE

# BatteryMinder®



- BATTERYMINDER® 2012 AGM - 2-AMP
- » 2830438

- BATTERYMINDER® EZ CONNECT
- » 2830411

- BATTERYMINDER® 12' CABLE
- » 2830410

- BATTERYMINDER® SPLITTER
- » 2830409

- BATTERYMINDER® RING TERMINAL
- » 2830437

### JUMPSTARTER BATTERY PACK

- Includes: Storage Case, Smart Jumper Cables, Car Charger, Wall Charger, Quick Start Guide
- 12,000 mAh Capacity
- Two 5V/2.1A USB Outputs
- 200 Lumen Flashlight
- Digital Battery Life Monitor
- 1 year limited warranty
- » 2830495

## VEHICLE CARE

### EXTENDED LIFE ANTI-FREEZE

- » 2880514 | 1 QT.
- » 2880513 | 2.5 Gal.

### DEMAND DRIVE FLUID

- » 2877922 | 1 QT.
- » 2877923 | 2.5 Gal.

### AGL

- » 2878068 | 1 QT.
- » 2878069 | 2.5 Gal.

### U-JOINT GREASE

- » 2871515 | 14 OZ.



## TOOL CHESTS

# READY TO WRENCH

If you've got a set of high-quality tools, keep them organized and protected in Polaris' line of premium tool chests and workstations. For even more storage, customize your tool chest by stacking the Polaris Standard Top or workstation and Roller Cabinets together. In the garage or in your vehicle—they go where you need them the most.

### POLARIS® ROLLER TOOL CABINETS & CHESTS

- Raise and release drawer pulls keeps drawers secure when moving
- Drawers use roller bearing glides
- Full width wrap-around aluminum drawer pulls
- Tubular theft proof lock and keys



**POLARIS® 41" STANDARD TOP CHEST**  
• 40½" W x 20½" H x 19¾" D  
» 2830450 | High Gloss Finish

**POLARIS® 41" 11-DRAWER ROLLER CABINET**  
• 41" W x 41½" H x 18" D  
» 2830408 | Textured Finish  
» 2830451 | High Gloss Finish

**POLARIS® 30" 5-DRAWER ROLLER CABINET**  
• 30¾" W x 41" H x 20¾" D  
» 2830406 | Textured Finish



**POLARIS® 41" PORTABLE WORKSTATION**  
• 41" W x 21½" H x 17¾"  
» 2830407  
Tools not included

**POLARIS® 30" PORTABLE WORKSTATION**  
• 30¾" W x 20½" H x 17¾"  
» 2830405  
Tools not included

### POLARIS 72" ROLLER CABINET

- Patented Quick Release™ drawer pull attaches across the drawer front for a sturdier, more secure handle
- Industrial Strength 12-gauge steel frame gives heavy duty support
- 2 extra-deep drawers allow storage of large and bulky tools
- 3 extra-long drawers provide storage for tools of all shapes and sizes
- Load capacity: 100-200 lbs. per drawer
- Heavy duty casters load rated 900 lbs. per caster  
» 2830492 | 72" W x 25" D x 47" H  
Tools not included



**POLARIS® HAND TOOL CADDY**  
» 2830431 | Silver | HANGS FROM FENCE RAIL OF ROLLER TOOL CABINETS  
Tools not included



**POLARIS® POWER TOOL CADDY**  
» 2830430 | Silver | Tools not included

## GENERATORS

### POLARIS® POWER

Powerful, portable, durable. These digital inverter generators are built to match your outdoor lifestyle, and are tested to the same rigorous standards as every Polaris® product.

**POLARIS POWER® INVERTER GENERATORS**  
1000 Watt - P136D6ANA  
2000 Watt - P136D6BNA  
3000 Watt - P136D6CNA



For more information visit [PolarisPower.com](http://PolarisPower.com)

## LIFTS/CREEPER

### POLARIS® VEHICLE LIFT

- Get fast, easy access to the underside of your vehicle with this handy lift
- Manual or pneumatic operation has smooth lift
- Raises vehicle up to 32 inches to make repairs and maintenance faster and easier  
» 2830425 | 2300 lbs  
» 2830424 | 1250 lbs

### POLARIS® VEHICLE LIFT ATTACHMENTS

- » 2830427 | ATV / Polaris ACE™

### POLARIS® X3 CREEPER

- Three positions: flat position, 45-degree angle or seated work stool
- Helps you maneuver any repair with ease
- Stay dry and warm—away from cold, wet cement floors
- Easily stores away when not in use  
» 2830429 | Black



## SHOP PRODUCTS



**POLARIS® MAGNETIC PARTS TRAY**  
» 2830432 | SILVER



**POLARIS® 12" HI-TORQUE RATCHETING DRIVER**  
» 2830434 | BLACK / BLUE



**GREASE GUN KIT**  
» 2871312 | SILVER



**POLARIS® LED POCKET FLASHLIGHT**  
» 2830436 | BLACK



**POLARIS® 33" TELESCOPIC MAGNET**  
» 2830435 | BLACK



**POLARIS® HEAVY DUTY SCRUBBER WIPES - 90CT**  
» 2830441



**POLARIS® SHOP TOWELS**  
» 2830440 | 64 CT  
» 2830402 | 200 CT  
» 2830403 | 200 CT REFILL